

GPS Pocket PC User Manual

Safety Instructions

- ♥ Please Read Before Proceeding.
- ♥ This product is not charged when shipped from the factory. When you use this product the first time, we recommend that you install the battery as illustrated and fully charge it for about 8 hours before use.
- ♥ Before you install the SIM card, make sure that tap the **ALL OFF** Button in **Wireless Manager** to turn off your Pocket PC's mobile phone, Bluetooth, and wireless LAN functions. And press the "Power Button" of the Pocket PC to turn off the screen. Otherwise, abnormal disconnection problems will occur.
- ♥ When you are on a plane, in a medical facility or at a gas station where wireless communications devices are not allowed and must be turned off, please go to **Wireless Manager** and select the **ALL OFF** Button to turn off your Pocket PC's mobile phone, Bluetooth, and wireless LAN functions. By pressing the "Power Button" of the Pocket PC, you only turn off the display.
- ♥ In case the Pocket PC is damaged, send it back to the dealer for repair. Do not attempt to disassemble the Pocket PC on your own; otherwise the warranty will be void.

Where to Find Information

For information on:	See this source:
Programs on your Pocket PC	This User's Guide and Pocket PC Help. To view Help, tap  and then Help .
Additional programs that can be installed on the Pocket PC	The Pocket PC Getting Started CD.
Connecting to and synchronizing with a desktop computer	Check the user's guide that comes with this product or look for the online help relevant to synchronization tools on the desktop PC or the Pocket PC.
Up-to-date information on your Pocket PC	http://www.microsoft.com/windowsmobile/

- ☒ This document lists the functions, specifications, and illustrations for reference only. The actual purchased product should be taken as the standard.

User Manual

SAFETY INSTRUCTIONS	2
WHERE TO FIND INFORMATION	2
1 Getting Started //	1-1
PACKAGE CONTENT	1-1
EXTERNAL VIEWS	1-2
<i>Hardware Hotkey Functions</i>	1-3
<i>Rear Side</i>	1-4
USING THE POCKET PC FOR THE FIRST TIME	1-5
<i>Charging Power and Power Supply</i>	1-5
<i>Re-installation or Replacing the Battery</i>	1-7
POWER ON AND OFF	1-8
<i>Sleep Mode</i>	1-8
<i>Turn on the Screen</i>	1-9
<i>Restarting the Pocket PC</i>	1-10
Reset	1-11
Default Settings	1-12
Clean Boot	1-13
2 Using the Pocket PC //	2-1
START	2-1
<i>Screen</i>	2-1
<i>Today Screen</i>	2-3
<i>Programs</i>	2-7
<i>System Application Programs</i>	2-9

M-DESK.....	2-11
ENTER INFORMATION ON YOUR POCKET PC	2-14
<i>Enter Text Using the Input Panel</i>	2-14
Type with the Soft Keyboard	2-16
Use Letter Recognizer.....	2-16
Use Block Recognizer.....	2-16
Use Transcriber	2-17
Select Typed Text	2-17
<i>Write on the Screen</i>	2-18
Write on the Screen.....	2-18
Select Writing	2-19
<i>Draw on the Screen</i>	2-20
Create a Drawing	2-20
Select a Drawing	2-21
<i>Record a Message</i>	2-21
Create a Recording	2-22
<i>Voice Commander</i>	2-23
3 Voice Command Satellite Navigation //	3-1
NAVIGATION DEVICE INSTALLATION.....	3-1
GPS NAVIGATION SOFTWARE INSTALLATION	3-2
CONDITIONS FOR USING GPS CAR NAVIGATION	3-2
SATELLITE DATA UPDATE	3-5
LOCATION SMS.....	3-8
GPS VIEWER	3-10

4	Using the Phone	4-1
	INSTALLING AND REMOVING THE SIM CARD	4-2
	USING THE PHONE	4-4
	<i>Adjusting the Phone Volume</i>	4-5
	TURNING THE PHONE ON OR OFF AND MAKING CALLS	4-6
	<i>Toolbar</i>	4-8
	<i>Call from Contacts</i>	4-9
	<i>Call from Speed Dial</i>	4-9
	<i>Call from the Call History</i>	4-10
	CUSTOMIZE YOUR PHONE	4-11
	<i>Add Ringtone</i>	4-12
	PHONE APPLICATION PROGRAMS	4-13
	<i>SIM Manager</i>	4-13
	Standard Display	4-13
	Full-Screen Display	4-14
	Copy Phonebook Information	4-15
	SMS Management	4-16
	<i>SIM Tool Kit</i>	4-16
	<i>SMS Sender</i>	4-17
	<i>Speed Dial</i>	4-18
	Hot Key Switch	4-18
	Frequently Dialed Screen	4-19
	Index Dial	4-20
	<i>Call Filter</i>	4-21

5	Customize Your Pocket PC //	5-1
	ADJUSTING SETTINGS	5-1
	NOTIFICATIONS.....	5-2
	POWER PREFERENCE SETTINGS	5-3
	BACKLIGHT	5-4
	MICROPHONE.....	5-5
	ADJUST VOLUME	5-6
	SCENARIOS	5-7
	QUICK LINK.....	5-8
	FIND AND ORGANIZE INFORMATION	5-10
	NAVIGATION BAR AND COMMAND BAR	5-11
	POP-UP MENUS.....	5-12
	REDEFINE HOT KEYS	5-13
6	Synchronization //	6-1
	WINDOWS VISTA PART	6-1
	WINDOWS XP/2000/98 PART.....	6-3
	INSTALLING AND USING ACTIVESYNC.....	6-4
	<i>FAQ About Synchronization</i>	6-6
	USB SYNCHRONIZATION	6-6
	SYNCHRONIZATION TOOL ON POCKET PC	6-9
	SYNCHRONIZING USING BLUETOOTH	6-10
7	Connections //	7-1
	CONNECTING TO THE INTERNET.....	7-1
	<i>Connection Wizard</i>	7-1
	<i>Setting the GPRS Connection</i>	7-3
	<i>Starting GPRS Connection</i>	7-5
	<i>Disconnecting GPRS</i>	7-6

USING BLUETOOTH.....	7-7
<i>Bluetooth Connection Wizard</i>	7-7
<i>Bluetooth Connection Setting</i>	7-9
Service.....	7-10
Serial Port.....	7-11
Bluetooth Headset	7-12
FTP Sharing	7-12
CSD TYPE	7-13
CONNECTING WITH A PERSONAL COMPUTER.....	7-14
WIRELESS LAN TRANSMISSION	7-14
8 Using Wireless LAN /	8-1
CONNECTING TO WIRELESS LAN	8-1
CONFIGURE YOUR WIRELESS NETWORK.....	8-3
<i>WLAN Setup Scenarios</i>	8-3
<i>Configure Your Wireless Network (Reference for</i> <i>a normal network setup)</i>	8-4
<i>Configure Your Wireless Network (Reference for</i> <i>Proxy setup)</i>	8-7
9 Sending and Receiving Messages /	9-1
E-MAILS AND SMS MESSAGES	9-2
<i>Synchronizing E-mail Messages</i>	9-3
<i>Connecting Directly to the Mail Server</i>	9-4
<i>E-mail Server Setup</i>	9-5
<i>Using E-mails and SMS</i>	9-7
<i>Direct Push Technology Alert</i>	9-10
Direct Push Technology Alert Settings	9-10

WINDOWS LIVE™ MESSENGER	9-12
<i>Setting Up</i>	9-13
<i>Working with Contacts</i>	9-14
<i>Chatting with Contacts</i>	9-15
MMS MESSAGE.....	9-16
<i>Create and Edit MMS</i>	9-16
BIRTHDAY REMINDER.....	9-18
NAME CARDS MANAGER	9-21
<i>Digitize New Name Cards</i>	9-21
<i>Name Cards Management</i>	9-24
10 Multimedia /	10-1
USING CAMERA	10-1
<i>Camera Mode</i>	10-2
Camera Mode Using Wizard.....	10-4
<i>Managing Pictures Shot by Continuous</i>	
<i>Shutter</i>	10-5
<i>Digital Video Mode</i>	10-6
Digital Video Mode Using Wizard	10-8
<i>Speed Shooting Using the Hardware Hotkeys</i>	10-9
MULTIMEDIA MANAGER.....	10-10
<i>Preview Multimedia Information</i>	10-10
<i>Slide Show Function</i>	10-11
<i>Multimedia Manager Tools</i>	10-12
IMAGE MAKER.....	10-13
IMAGE WIZARD	10-15
FM TUNER.....	10-16

11 Companion Programs /	11-1
CALENDAR: SCHEDULING APPOINTMENTS AND MEETINGS	11-2
<i>Create an Appointment</i>	11-3
<i>Use the Summary Screen</i>	11-4
<i>Create Meeting Requests</i>	11-4
Schedule a Meeting	11-5
CONTACTS: TRACKING FRIENDS AND COLLEAGUES	11-6
<i>Create a Contact</i>	11-7
<i>Find a Contact</i>	11-8
<i>Use the Summary Screen</i>	11-9
TASKS: KEEPING A TO DO LIST	11-10
<i>Create a Task</i>	11-11
<i>Use the Summary Screen</i>	11-12
NOTES: CAPTURING THOUGHTS AND IDEAS	11-13
<i>Create a Note</i>	11-14
WORD MOBILE	11-15
EXCEL MOBILE	11-18
<i>Tips for Working in Excel Mobile</i>	11-20
POWERPOINT MOBILE	11-21
WINDOWS MEDIA PLAYER	11-22
INTERNET EXPLORE	11-24
<i>Using Internet Explore</i>	11-24
Browse the Internet	11-25
View Mobile Favorites and Channels	11-26
<i>The Mobile Favorites Folder</i>	11-26
<i>Favorite Links</i>	11-27

<i>Synchronize Mobile Favorites</i>	11-27
Create a Mobile Favorite.....	11-27
Save Pocket PC Memory	11-28
12 Maintaining the Pocket PC //	12-1
BACKUP UTILITY	12-1
<i>Storage Space</i>	12-1
<i>Backup Files</i>	12-2
Wizard Mode.....	12-2
Standard Mode	12-2
<i>Advanced Settings Options</i>	12-3
<i>Restore Files</i>	12-5
Wizard Mode.....	12-5
Standard Mode	12-6
ADDING OR REMOVING PROGRAMS	12-7
<i>Add Programs Using Synchronization Tools</i>	12-7
<i>Add a Program Directly from the Internet</i>	12-8
<i>Add a Program to the Start Menu</i>	12-9
<i>Remove Programs</i>	12-10
MANAGE MEMORY	12-11
<i>View Memory Status</i>	12-11
<i>Find Available Memory</i>	12-12
SYSTEM INFORMATION	12-15

13 Voice Commander //	13-1
STARTING VOICE COMMANDER	13-2
VOICE COMMAND FORMAT	13-3
VOICE COMMANDER SETTINGS	13-5
<i>Contacts Settings Page</i>	13-5
<i>Application Settings Page</i>	13-8
<i>Music Settings Page</i>	13-10
<i>Advanced Settings Page</i>	13-13
FAQ	13-14
14 Specifications //	14-1
15 Regulation Notice and Safety Declaration //	15-1
SAR INFORMATION	15-1
HEALTH AND SAFETY INFORMATION	15-2
16 FAQ //	16-1

X-10

1 Getting Started

Package Content

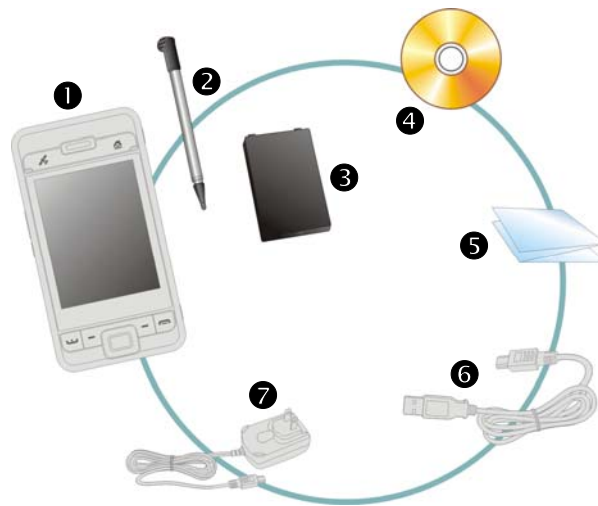

Pocket PC, stylus, Battery, Getting Started CD, User Guide, AC adapter, USB cable, headset and Leather case.



- ❶ Pocket PC
- ❷ Stylus
- ❸ Battery
- ❹ Getting Started CD
- ❺ User Guide
- ❻ USB Cable
- ❼ AC Adapter

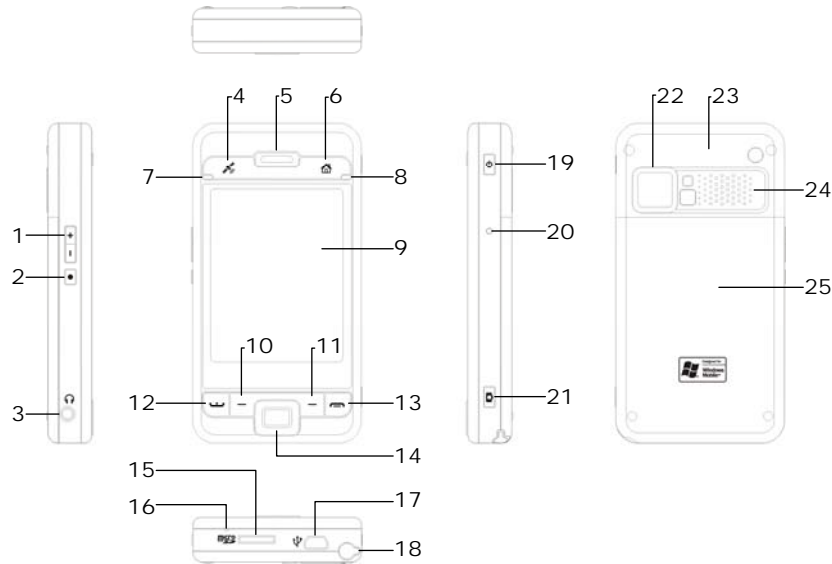

External Views

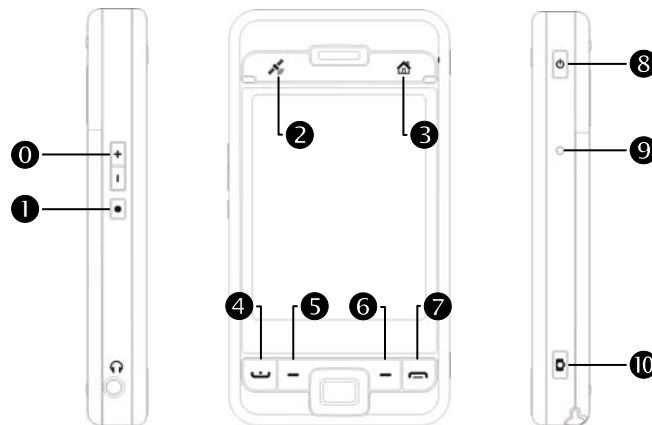

- | | |
|---------------------------------------------------------------------------------------------------|----------------------------------------------------------------------------------------------------|
| 1 Volume control key | 2 Voice Commander |
| 3 Earphone and microphone jack | 4 Hot key reserved for GPS AP |
| 5 Cell Phone speaker | 6 M-Desk hot key |
| 7 WLAN Active LED (Orange) | 8 Power Charging LED (Red) |
| Bluetooth Active LED
(Blue, blinks once) | Cell phone Active LED (Green) |
| GPS Active LED (Blue, blinks twice) | |
| 9 Touch screen | 10 Left Soft-Key |
| 11 Right Soft-Key | 12  Send button |
| 13  End button | 14 Navigation button. Press the center of the button to set as launch key. |
| | 15 MicroSD Slot |
| | 16 Microphone |
| | 17 Mini USB port |
| | 18 Stylus holder. Slide the stylus out of the holder. This is a two-stage push-pull stylus. |
| | 19 Power button |
| | 20 Reset button |
| | 21 Camera Shutter |
| | 22 Built-in camera lens/ preview mirror |
| | 23 Hidden antenna for Cell Phone |
| | 24 Speaker |
| | 25 Back cover. Battery is inside. |

Hardware Hotkey Functions



Hardware Button	Short Press (Press once and release)	Long Press (Press for a few seconds and release)
①	<ul style="list-style-type: none"> ■ Adjust volume ■ Zoom in/out during camera mode 	--
①	Connect to Voice Commander	Connect to Notes
②	Hot key reserved for GPS AP	--
③	Connect to M-Desk	--
④ 	Connect to Phone /dial/redial/answer	Telephone hold
⑤	Left Soft-Key: Soft-keys on left and right to operate function buttons at bottom of display.	--
⑥	Right Soft-Key	--
⑦ 	<ul style="list-style-type: none"> ■ Hang up during call ■ Disconnect during GPRS connection ■ Skip to Today's screen while in other programs 	<ul style="list-style-type: none"> ■ Turn off phone if it is on ■ Turn on phone when it is off
⑧	Power Button = open or close screen	--
	Power Button + Reset Button = Cold boot	--
⑨	Reset Button	--
⑩ 	Camera or Camera Shutter	Video recorder

Rear Side

- 1 Insert the SIM card into the SIM card slot with its golden contacts facing down. Follow the picture indicated on the Pocket PC.
- 2 Main battery
- 3 Back cover
- 4 Follow the direction in the illustration to install the main battery.
- 5 Main battery lock

■ Installing the SIM Card

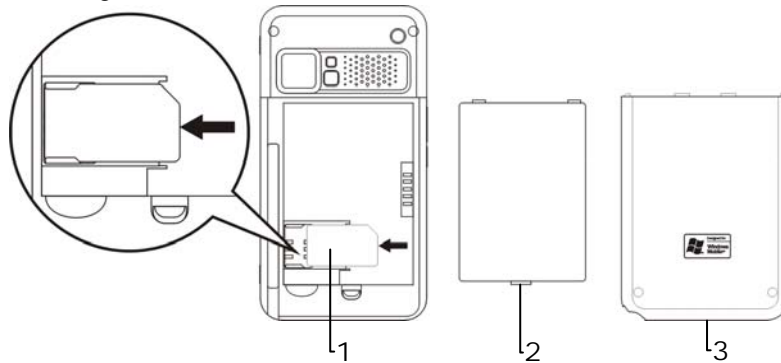

■ Installing the Battery

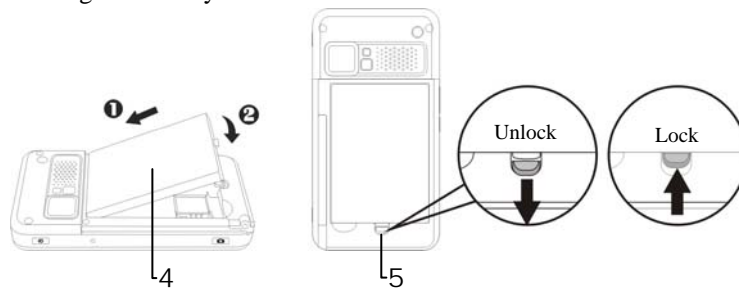

Using the Pocket PC for the First Time

Charging Power and Power Supply

- ❶ Connect the AC adapter plug to any household power outlet.
- ❷ Connect the other plug from the AC adapter to the USB port. The Pocket PC starts to charge automatically.
- ❸ If you need to connect Pocket PC and desktop computer, you could connect the USB cable to the USB port. And then connect the other end of the USB cable to the USB port on the desktop computer. Your Pocket PC will also charge at the same time.

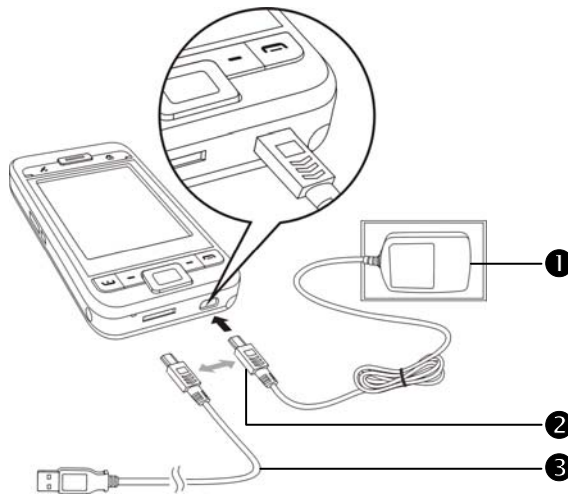

1. Remove the back cover.
(If you are opening this product for the first time, the main battery and the Pocket PC are packed separately inside the product package.)
2. Install the main battery properly and lock the battery securely.

3. Please connect one side of the AC adapter plug to any household power outlet and connect the other side of plug from the AC adapter to the USB port. The Pocket PC will start to charge automatically.
4. Cold Boot: Press and hold the “Power Button” with one hand, and use the stylus tip to press the “Reset Button” with the other hand. Release the “Power Button” and the “Reset Button” at the same time. Wait for the Pocket PC to restart and follow the instructions on the screen to complete screen alignment.
5. It will take about 8 hours to fully charge the battery after the first time you open the package. Subsequent charging will only take about 3 hours. After charging, you can disconnect the AC adapter and carry the Pocket PC around portably. To maintain smooth operation, charge the power regularly.
6. View the battery icon  on the upper right corner to check the power usage condition.
7. The LED indicator on the upper right of Pocket PC will display the charging and function usage status.

Charging	Fully charged	Insufficient power
Red LED lights up	Red LED goes off Green LED lights up	Red LED flashes
Phone is on	Caution or Warning	
Green LED flashes	Orange LED flashes	

8. The LED indicator on the upper left of Pocket PC

WLAN Active	Bluetooth Active	GPS Active
Orange LED flashes	Blue LED blinks once every 4 seconds	Blue LED blinks twice every 4 seconds

Re-installation or Replacing the Battery

If the phone, GPRS or wireless LAN connection function is already activated, deactivate it first and then replace the battery.

1. Slide and remove the back cover of Pocket PC.
2. You may poke down to unlock the main battery lock in order to remove the battery.
3. Replace the main battery and lock it properly. When you remove the main battery, your Pocket PC will enter the sleep mode.
4. Slide the back cover into the groove, and reinstall the back cover.

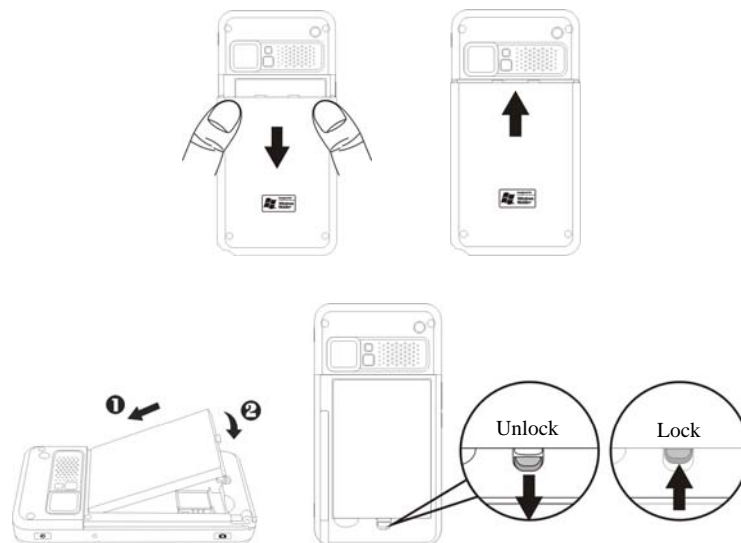

Power On and Off

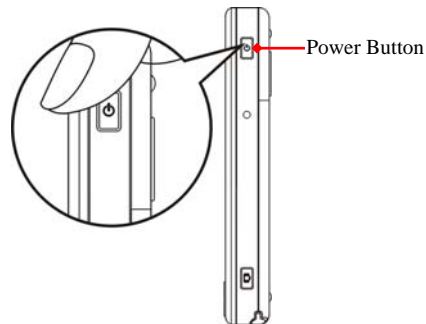

Sleep Mode

1. Press the “Power Button” of the Pocket PC to enter the Sleep mode. At this time, the screen is turned off and all peripheral devices enter the power-saving mode. But if the phone is turned on, it is still in the call waiting mode.
2. To turn on the screen later, just press the “Power Button.”



3. Tap , **Settings**, the **System** tab, **Power** and then the **Advanced** tab to set the device to turn off automatically after waiting for a certain time period.

Turn on the Screen

This product is designed with a power-saving feature. If the screen is turned off, press the “Power Button” of the Pocket PC to turn it on.

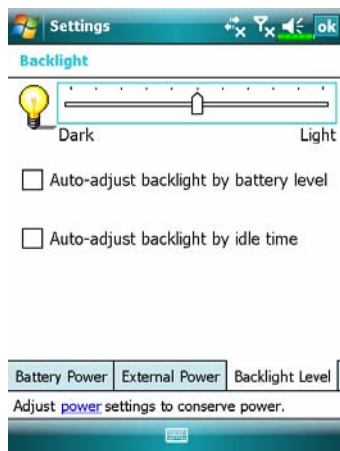

If the screen is too dark and you cannot see clearly, set the proper brightness level for the backlight.

Tap , **Settings**, the **System** tab, **Backlight** and then the **Backlight Level** tab.



Using the Stylus to Touch the Screen

- Your Pocket PC is designed for graphics-based operation. Generally speaking, we usually “use the stylus to perform basic actions such as tap, drag, and tap and hold” on the touch screen. Other actions such as reset and cold boot will require the use of the stylus tip.
- Pull the stylus to full-length to make it easier to tap the screen during operation. When kept completely in the stylus holder, the stylus length shortens.
- Avoid heavily pressing on the touch screen with the stylus or your fingers.

Restarting the Pocket PC

Appropriate situation: If the Pocket PC is unable to maintain normal operation, has no response, or if the screen is frozen.

For your consideration, factoring into your safety and convenience, please refer to the following instructions in order:

1. Reset	Press the “Reset Button” of Pocket PC with the tip of the stylus.
2. Default Settings procedures	If the touch screen is functional, please tap  , Programs, Utilities , and then Default Settings .
3. Clean Boot	Hold the “Power Button” and press once on the “Reset Button” with the tip of the stylus, and release both buttons simultaneously. Next, continually hold the End Button  until the system inquiry screen is displayed, then release the End Button. Answer the question(s).

Reset

- Reset method: Press the “Reset Button” of Pocket PC with the tip of the stylus.

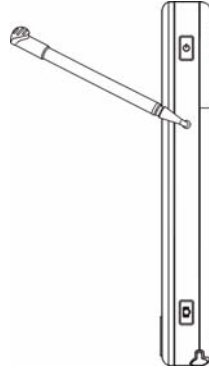

- Appropriate situation: If the Pocket PC is unable to maintain normal operation, has no response, or if the screen is frozen.
- Result: In a moment, when Pocket PC automatically completes the system startup process, the last display will be the Today screen. This will retain the Microsoft Windows, factory pre-installed applications, user’s input data, newly installed programs, and user custom settings.

Default Settings

Tap , **Programs, Utilities**, and then **Default Settings**.



1. If this application is inadvertently accessed, please select the  to the upper right of the screen to exit, the system will not be affected.
2. If you are certain that you wish to perform this action, please select the data input block on the right, and enter the authorized code in the block to the left. Then tap the **OK** button.

⚙️ **Appropriate situation:** If the Pocket PC is unable to maintain normal operation, but the touch screen is functional. Please refer to the instructions in this section to troubleshoot.

⚙️ **Result:** This will retain only the Microsoft Windows, and factory pre-installed applications. Other settings such as user's input data, newly installed programs, and user custom settings will all be cleared.

Clean Boot

- ❁ Cold boot method: Hold the “Power Button” of the Pocket PC with one hand while holding the stylus tip to push in the “Reset Button” with the other. Simultaneously release both the “Power Button” and “Reset Button”.

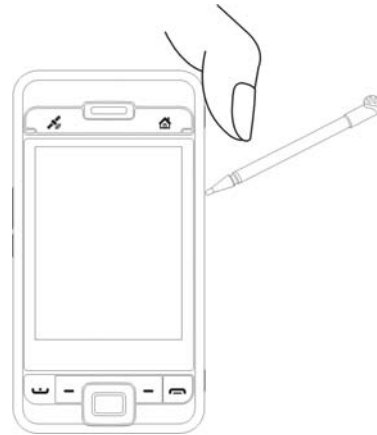



- ❁ Appropriate situation: If a previous reset has already been attempted and the Pocket PC is still unable to maintain normal operations, has no response, or if the screen is frozen.

- ❁ Before executing the preceding “Cold boot method”, please carefully consider the following instructions and then decide on the cold boot method.

1. After a cold boot is performed, if no buttons are pressed, when Pocket PC automatically completes the system startup process, the last display will be the Today screen. This is identical to the reset result.
2. If a previous reset has already been attempted but the Pocket PC is still unable to maintain normal operation, consider the following solution:
After cold boot, hold the End Button  on the bottom right of Pocket PC until the system inquiry screen is shown, and then release the End Button. Next, please read thoroughly through the instructions on cold booting before continuing carefully.

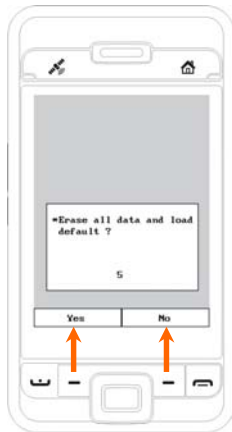
Perform cold boot and hold the End Button . Please refer to the following instructions before careful consideration.



 Erase all data and load default?

The default is “No.” If Yes or No was not selected, after a few seconds the system will automatically execute the default No.

If you long press Left Soft-Key for a few seconds to select “Yes,” then the system will erase all data and load default. After your Pocket PC restarts, follow the instructions on the screen to complete.

 Caution!

1. After performing a cold boot, the system will retain Microsoft Windows and pre-installed programs. If you answer “Yes” to the question displayed after a cold boot, other items such as the user’s input data, newly installed programs and user settings will be lost.
2. There are two ways to retain your data, loaded default and registry:
 - ① Perform a Reset.
 - ② Performing a Cold Boot, and answer “No” when the above question displays.

2 Using the Pocket PC /

Start

Screen

Tap , **Settings**, the **System** tab, and then **Screen**.

The first time you use or cold boot the pocket PC, the system will ask you to align the screen. Kindly continue to tap the center of each cross (+) that appears and follow the screen instructions to complete the operation. If you feel that the position is not quite accurate while tapping on the screen, you follow the help for this section to align the screen again.

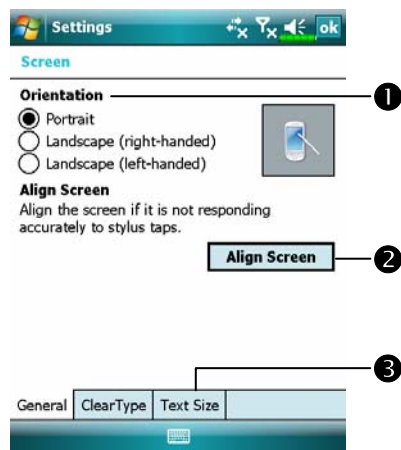

1 Orientation:

- Portrait (default)
- Landscape (right-handed)
- Landscape (left-handed)

2 Tap the **Align Screen** button to calibrate the screen. When Align Screen appears, use the stylus to tap the center of the cross (+) until the next cross appears, then follow the screen instructions to complete the operation. Finally, tap **ok** to exit.

3 **Text Size** tab: For selecting the desired text size.



The following steps will bring you into the touch screen calibration mode. These steps provide a faster and more efficacious way to enter the touch screen calibration mode. And they also provide a method of getting into **Screen** program for when the touch screen dislocation is so severe that you completely cannot select or do anything using the stylus.

1. Simultaneously press the **Left Soft-Key** on the bottom-left of the Pocket PC and the execution button in the center of the navigation pad.
2. Release these two buttons at the same time, and you will enter the calibration screen.

Today Screen





















When you turn on your Pocket PC for the first time each day (or after 4 hours of inactivity), you will see the “Today screen”. You can also display it by tapping  and then **Today**. On the “Today screen”, you can see at a glance the important information for the day.



























- 1  Start. Tap to switch to a program.
- 2 Tap to enable or disable the GPRS connection feature.
- 3  Antenna icon. Tap to turn the phone on or off.
- 4  Speaker icon. For adjusting volume.

- 5 Time. Tap to display the current date and time, and the upcoming appointments. Tap and hold the time area to select analog or digital clock display from the list.
- 6 Today screen. Displays important information for the day. Tap on any item to enter its relevant setup screen.
- 7 Quick Link. Tap to quick link to a program.
- 8 The icons mean you can tap to quick link to programs, such as **Wireless Manager, Scenarios**, Call Filter status, etc.
- 9 Tap to quick link to **SpeedDial**. Tap to quick link to **Contacts**.



The following table lists the icons that you may see on the Navigation Bar or the Command Bar. Kindly refer to the “Meaning” column for explanation or tap on the icon to access the instant message.











Icon	Meaning (Located on the Navigation Bar at the top of the screen)
	Speaker is on
	Ringer off
	Pending alarm
	Battery charging
	Battery level
	Low battery
	Battery power is very low
	Battery is fully charged
	No battery
	New instant message
	New e-mail or text message (SMS)
	New voice mail
	If there is not enough space on the screen to display all notification icons, tap this icon to view all icons.
	Active connection to computer
	Active Sync is synchronizing
	Sync error
	PowerPoint slide show
	Bluetooth
	Missing SIM card
	The phone is turned off. Flight mode in use.
	The phone is turned on. Signal strength.











Icon	Meaning (Located on the Navigation Bar at the top of the screen)
	Radio connected
	No signal. No service. The device has not yet connected to a network.
	Lost signal. The device is searching for a signal.
	Missed call
	Voice call in progress
	Data call in progress
	Calls are forwarded
	Call on hold
	Missed call
	Roaming
	GPRS not in use
	GPRS available
	GPRS connected
	Synchronize over GPRS in use
	EDGE available
	EDGE connected
	Synchronize over EDGE in use
	Wireless LAN Active
	Wireless LAN Data Calling
	Wireless LAN in use

Icon	Meaning (Located on the Command Bar at the bottom of the screen)
	General Mode. Set the scenario suitable for each environment.
	Meeting Mode. Set the scenario suitable for each environment.
	Outdoor Mode. Set the scenario suitable for each environment.
	Silent Mode. Set the scenario suitable for each environment.

Programs

You can switch from one program to another by selecting it from the  menu. (You can customize which programs you see on this menu. For information, see “Adjusting Settings” section.) To access some programs, you’ll need to tap , **Programs**, and then the program name.

Icon	Programs	Description
	Games Group	Bubble Breaker, Solitaire
	Multimedia Group	Camera, FM Tuner, Image Maker, Image Wizard, Multimedia Manager
	Office Mobile Group	Excel Mobile, PowerPoint Mobile, Word Mobile
	Phone Group	Add Ring tone, Call Filter, MMS Message, Scenarios, SIM Manager, SMS Sender, Speed Dial
	Utilities Group	Backup Utility, Birthday Reminder, Bluetooth Manager, Default Settings, M-Desk, Namecard Manager, WLAN Utility
	Voice Commander Group	Voice Commander, Voice Commander Settings
	GPS Group	GPS Viewer, Location SMS, Satellite Data Update
	ActiveSync	Synchronize information between your Pocket PC and desktop computer.
	Calendar	Keep track of your appointments and create meeting requests.
	Contacts	Keep track of your friends and colleagues.

Icon	Programs	Description
	Notes	Create handwritten or typed notes, drawings, and recordings.
	Tasks	Keep track of your tasks.
	Messaging	Send and receive e-mail messages.
	Internet Explorer	Browse Web and WAP sites, and download new programs and files from the Internet.
	Windows Live	MSN related programs.
	Windows Live Messenger	Send and receive instant messages with your MSN contacts.
	Calculator	Performs basic calculations.
	Pictures & Videos	Take, view, and edit pictures.
	Windows Media Player	Plays movies or sound files.
	File Explorer	Manages files or folders.
	Wireless Manager	Manage the mobile phone, Bluetooth, and wireless LAN functions.

You can also switch to some programs by pressing a program button. Your Pocket PC has one or more program buttons located on the front or side of the Pocket PC. The icons on the buttons identify the programs they switch to. For more information, refer to “Redefine Hot Keys” section.

System Application Programs

 Settings, the **Personal** tab

Program	Description
Buttons	Set the hot key for Pocket PC hardware button.
Input	Set the details about the input method.
Lock	Set the access rights and password of Pocket PC.
Menus	Set the items displaying on the  Start menu.
Owner Information	Input owner information.
Phone	Set the details about the phone.
Sounds & Notifications	Set the volume and notification method.
Today	Set the look of Today screen and display information.

 **Settings, the System tab**

Program	Description
About	Display the important information about the Pocket PC.
Backlight	Set the details about the backlight and brightness.
Certificates	For network identification to prevent unauthorized access.
Clock & Alarms	Set the time and alarms.
Memory	View the memory usage, and the list of running programs, etc.
Microphone	Set the microphone volume.
Power	View the power usage condition, whether or not to power off after a waiting period.
Regional Settings	Set the region and information display formats such as date, time, etc.
Remove Programs	Remove programs that are no longer used.
Screen	Aligning the screen is helpful in determining the touch accuracy. You can select the portrait or landscape orientation.
System Information	View the system information.

 **Settings, the Connections tab**

Program	Description
Beam	Set if receiving end will accept beam data automatically or not.
Connection Wizard	Select the appropriate country and carrier name.
Connections	Set the network connection.
CSD Type	Set Pocket PC to simulate a modem and access the Internet through the built-in GSM device.
Network Cards	Set the details about network cards.
USB to PC	Change the type of USB connection.

M-Desk

Press the hot key  on the upper part of the Pocket PC to link to **M-Desk**.

Tap , **Programs, Utilities**, and then **M-Desk**.

You can categorize programs or even change the background picture on the panel according to your personal preferences. Categorizing, renaming, deleting or editing the text color of program names under **M-Desk** will not affect the default setting of the Pocket PC.

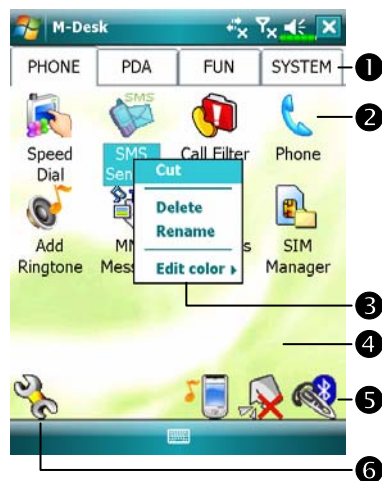



1 Tap **Phone, PDA** or other tabs to switch to other categories.

Tap and hold the tab to display a pop-up menu that allows you to Rename, Move forward or Move back.

2 The program icon selected for this category. Tap to run this program.

3 Tap and hold program. A pop-up menu appears and allows you to Rename, Delete, Cut, or edit the text color of the program name.

4 Tap on empty space and the pop-up menu allows you to add New, Paste or Change ground.

5  Switch Scenario  Enable or disable the speakerphone

 Enable or disable the Bluetooth earphone function

6  Enter Categories Setup screen

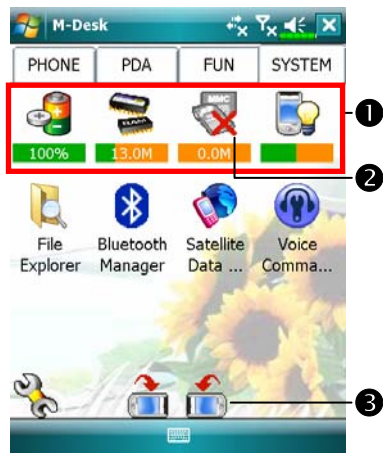

☰ System category screen

❶ This category already has these programs that are automatically selected by the system which you cannot move or delete. All relevant information is updated automatically.

❷ If no storage card is installed, its icon changes to gray and will be marked with a red X.

❸ Change screen orientation.

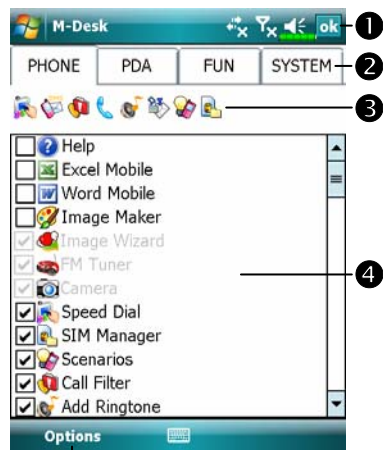

☰ Categories Setup screen

❶ Exit the Categories Setup screen.

❷ Tap **Phone, PDA** or other tabs to select preferred programs. A maximum of 12 programs are allowed for each category.

❸ Icons for programs selected under this category.

❹ Program selection area:

Tap to check the program name to confirm selection.

Tap on again to change it back to to cancel selection.

If it is already checked in other categories, the icon is in gray and you cannot select this item.

❺ Tap **Options** and then **Style**

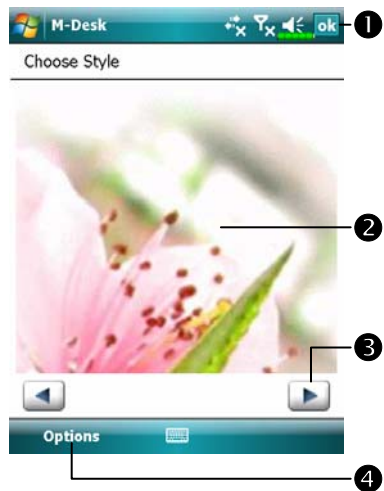

Choose to change the background picture.



☰ Choose Style screen

❶ Exit Choose Style screen.

❷ Viewing area.

❸   View the previous or next picture.

❹ Tap **Options** and then **Classify Config** to enter the Categories Setup screen.

Enter Information on Your Pocket PC

You have several options for entering new information:

1. Use the input panel to enter typed text, either by using the soft keyboard or other input method.
2. Write directly on the screen.
3. Draw pictures on the screen.
4. Speak into your Pocket PC microphone to record a message.
5. Use synchronization tools to synchronize or copy information from your desktop computer to your Pocket PC. For more information, see Help on your desktop computer.

Enter Text Using the Input Panel

Use the input panel to enter information in any program on your Pocket PC. You can either type using the soft keyboard or write using **Letter Recognizer**, **Block Recognizer**, or **Transcriber**. In either case, the characters appear as typed text on the screen.

To show or hide the input panel, tap the Input Panel button. Tap the arrow next to the Input Panel button to see your choices.



- ❶ Select an input method.
- ❷ Tap to see your choices.
- ❸ Input Panel button.

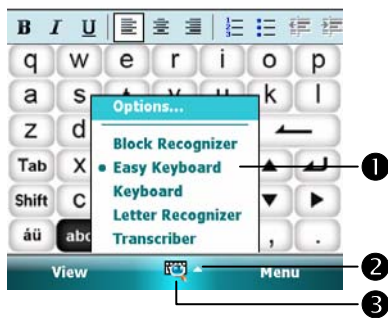

When you use the input panel, your Pocket PC anticipates the word you are typing or writing and displays it above the input panel. When you tap the displayed word, it is inserted into your text at the insertion point. The more you use your Pocket PC, the more words it learns to anticipate.



- ❶ Tap here if this is the right word.

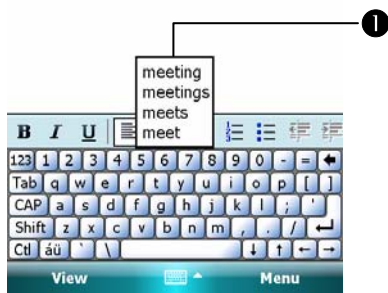

☑ To change word suggestion options, such as the number of words suggested at one time, tap  **Settings**, the **Personal** tab, **Input**, and then the **Word Completion** tab.

Type with the Soft Keyboard

1. Tap the arrow next to the Input Panel button and then **Keyboard**.
2. On the soft keyboard that is displayed, tap the keys with your stylus.

Use Letter Recognizer

With Letter Recognizer you can write letters using the stylus just as you would on paper.

1. Tap the arrow next to the Input Panel button and then **Letter Recognizer**.
2. Write a letter in the box.

When you write a letter, it is converted to typed text that appears on the screen. For specific instructions on using **Letter Recognizer**, with **Letter Recognizer** open, tap the question mark next to the writing area.

Use Block Recognizer

With Block Recognizer you can input character strokes using the stylus that are similar to those used on other Pocket PCs.

1. Tap the arrow next to the Input Panel button and then **Block Recognizer**.
2. Write a letter in the box.

When you write a letter, it is converted to typed text that appears on the screen. For specific instructions on using **Block Recognizer**, with **Block Recognizer** open, tap the question mark next to the writing area.

Use Transcriber

With **Transcriber** you can write anywhere on the screen using the stylus just as you would on paper. Unlike **Letter Recognizer** and **Block Recognizer**, you can write a sentence or more of information. Then, pause and let **Transcriber** change the written characters to typed characters.

1. Tap the arrow next to the Input Panel button and then **Transcriber**.
2. Write anywhere on the screen.

For specific instructions on using **Transcriber**, with **Transcriber** open, tap the question mark in the lower right hand corner of the screen.

Select Typed Text

If you want to edit or format typed text, you must select it first. Drag the stylus across the text you want to select. You can cut, copy, and paste text by tapping and holding the selected words and then tapping an editing command on the pop-up menu, or by tapping the command on the **Menu** menu.

Write on the Screen

In any program that accepts writing, such as the **Notes** program, and in the **Notes** tab in **Calendar**, **Contacts**, and **Tasks**, you can use your stylus to write directly on the screen. Write the way you do on paper. You can edit and format what you've written and convert the information to text at a later time.

Write on the Screen

Tap **Menu** and then check **Draw** to switch to writing mode. This action displays lines on the screen to help you write.

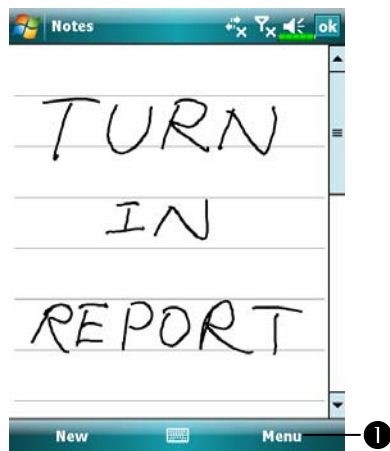

❶ Tap **Menu** and then check **Draw**.

Use your stylus like a pen now.

▣ Some programs that accept writing may not have the **Draw** function. See the documentation for that program to find out how to switch to writing mode.

Select Writing

If you want to edit or format writing, you must select it first.

1. Tap and hold the stylus next to the text you want to select until the insertion point appears.
2. Without lifting, drag the stylus across the text you want to select.

If you accidentally write on the screen, tap **Menu**, then **Undo** and try again. You can also select text by tapping **Menu** and then **Draw** to deselect it and then dragging the stylus across the screen.

You can cut, copy, and paste written text in the same way you work with typed text: tap and hold the selected words and then tap an editing command on the pop-up menu, or tap the command on the **Menu** menu.

Draw on the Screen

You can draw on the screen in the same way that you write on the screen. The difference between writing and drawing on the screen is how you select items and how they can be edited. For example, selected drawings can be resized, while writing cannot.

Create a Drawing

Cross three ruled lines on your first stroke. A drawing box appears. Subsequent strokes in or touching the drawing box become part of the drawing. Drawings that do not cross three ruled lines will be treated as writing.

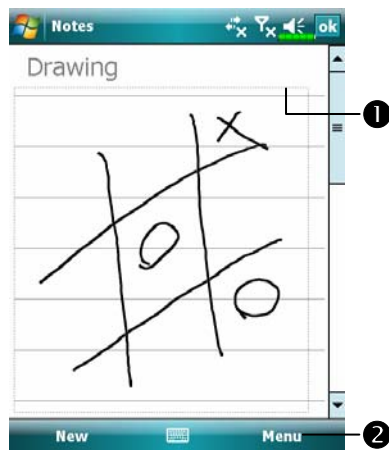

- ❶ The drawing box indicates the boundaries of the drawing.
- ❷ Tap **Menu** and then check **Draw**.

▣ You may want to change the zoom level so that you can more easily work on or view your drawing. Tap **Menu**, **Zoom** and then a zoom level.

Select a Drawing

If you want to edit or format a drawing, you must select it first. Tap and hold the stylus on the drawing until the selection handle appears. To select multiple drawings, tapping **Menu** and then **Draw** to deselect it and then drag to select the drawings you want.

You can cut, copy, and paste selected drawings by tapping and holding the selected drawing and then tapping an editing command on the pop-up menu, or by tapping the command on the **Menu** menu. To resize a drawing, make sure the **Draw** function is not selected, and drag a selection handle.

Record a Message

In any program where you can write or draw on the screen, you can also quickly capture thoughts, reminders, and phone numbers by recording a message. In **Calendar**, **Tasks**, and **Contacts**, you can include a recording in the **Notes** tab. Refer to “Voice Recording Format” section.

In the Notes program, you can either create a stand-alone recording or include a recording in a written note. If you want to include the recording in a note, open the note first. In the Inbox program, you can add a recording to an e-mail message.

Create a Recording

1. Hold your Pocket PC's microphone near your mouth or other source of sound.
2. Press and hold the Record hardware button on your Pocket PC until you hear a beep.
3. While holding down the Record button, make your recording.
4. To stop recording, release the Record button. Two beeps will sound. The new recording appears in the note list or as an embedded icon.

▣ You can also make a recording by tapping the **Record** button on the Recording toolbar.

To play a recording, tap it in the list or tap its icon in the note.



❶ Indicates an embedded recording.

❷ Tap to begin recording.

❸ Recording toolbar.

❹ Tap **Menu** and then check **View**

Recording Toolbar.

Voice Commander

By default, the system sets the button on the side of the Pocket PC as the “Voice Commander Button.” Press this button to launch the Voice Commander. For details on how to use this function, please refer to the Voice Commander section.



3 Voice Command Satellite Navigation /

Navigation Device Installation

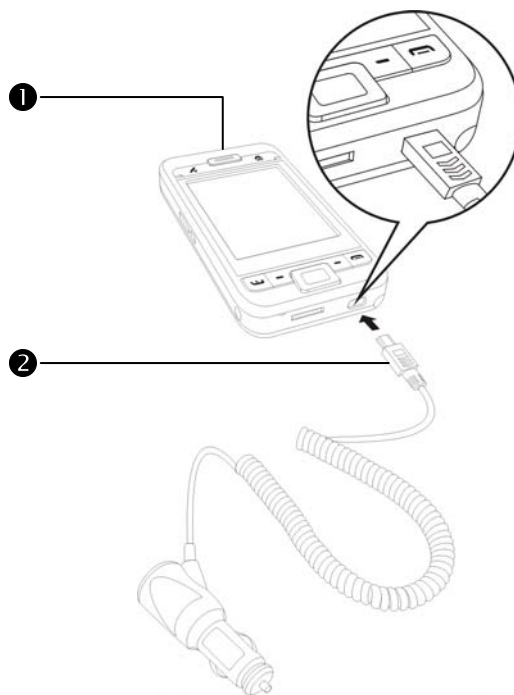

❶ Pocket PC

❷ Car Charger (* optional): when Pocket PC is low on power, recharge by connecting one end to the car cigarette lighter/12 volt power outlet and the other end to the socket on base of Pocket PC.

Attention: The GPS signal receiver is built into the Pocket PC. If car windscreen has heat reflective metallic film, or Pocket PC is obstructed by objects, then the receptivity of the GPS will be adversely affected.

GPS Navigation Software Installation

Please follow your car navigation system operating manual's instructions on software installation in order to use the navigation function.

Conditions for Using GPS Car Navigation

By using this system you are agreeing to the following conditions:

1. When using this device, please use with matching car mount. Affix device securely to the car mount. Please be aware that installation in the areas depicted below is forbidden and is strictly prohibited.

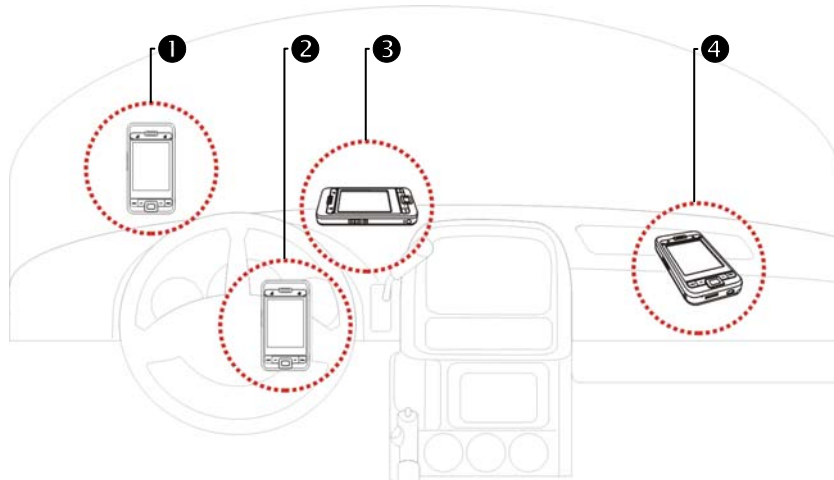

- ❶ Do not place where it will obstruct driver vision
- ❷ Do not place over air bag
- ❸ Do not place where it can not be securely attached
- ❹ Do not place in path of activated air bag

2. Please set navigation destination before driving. Do not operate this system while driving.
3. Please use this system with care. If any harm results from careless use of this system, the responsibility for safe driving resides with the driver.
4. GPS positioning is limited by weather and usage location (tall buildings, tunnels, underpasses, trees, bridges). Most GPS do not work indoors, nor can GPS signals penetrate buildings, car sun shades and heat reflective film with metallic content. Please install GPS outdoors with clear line of sight. Beneath the windshield at the front of the car is a common choice, and the windshield should be free of heat reflective film.
5. The GPS system is built and operated by the U.S. Department of Defense which is also responsible for its maintenance and calibration. Any changes made by them may affect the operation and accuracy of the GPS system.
6. Wireless devices (mobile phones, speed radar detectors) will all interfere with the satellite signal and cause unreliable signal reception.
7. The GPS position fix is provided only for the driver's reference and should not affect actual driver behavior.
8. The electronic map data provided in the navigation system is for normal reference only and not intended for high precision applications. The user should determine their exact location based on actual road conditions.
9. The route provided by the navigation system, the audio cues and intersection data are derived from recommended optimal route calculated using the electronic map data. This is provided for the driver's reference only, the driver should decide their chosen route according to actual road conditions.

10. When not in use, please do not leave the device inside the car. If exposed directly to sunlight, the battery may overheat and cause damage to this device. This may endanger the vehicle as well.

Satellite Data Update

Tap , **Programs**, **GPS**, and then **Satellite Data Update**.

Login to the provider's server to download instant satellite data and enable the GPS function. Note: either of the following connections allows your Pocket PC to download the latest GPS data. If there is more than one connection available, the system will automatically select the best connection, in the following order:

1. Synchronization connection: Connect your Pocket PC to a PC (Desktop or Notebook). Please note that your PC must be online.
2. Wireless LAN connection.
3. GPRS connection: Roaming mode cannot update GPS data automatically. If necessary, change to manual mode.

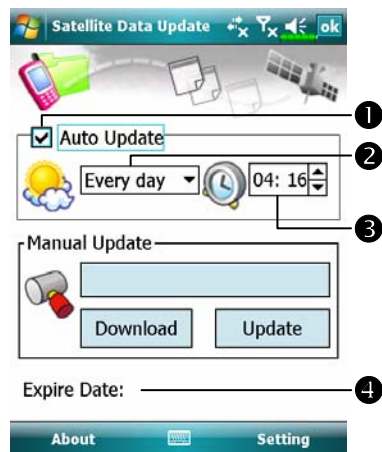

☛ The system will update GPS data automatically based on a schedule.

Follow these steps:

- 1 Check the automatic update checkbox.
- 2 Set the date.
- 3 Set the time.
- 4 The text shows the expiration date of the GPS data. On the due date, the system will pop up a warning message. Refer to the following instruction about the **Today** screen.



Expire Date:

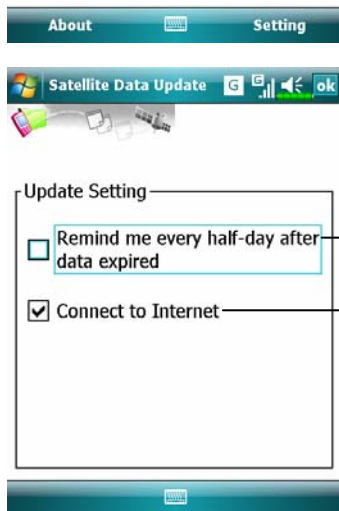

Tap the **Download** Button to update the GPS data manually. The figure on the left shows how to download using the synchronization connection.

Tap the **Setting** Button in the **Satellite Data Update** main screen to open the dialog in the left figure.

- ① Check the expiration checkbox to activate the reminder function on the due date.
- ② The default value is checked. The system will automatically update the data when online. Costs will be incurred when connecting over the GPRS, so consider carefully before activating this function.

After setting your Pocket PC to the following connection mode and activating the automatic update and Internet connection functions, the system will automatically download the latest GPS information periodically.

1. Synchronization connection. Make sure that your Pocket PC is connected to the PC, and that the PC is online.
2. Wireless LAN connection.
3. GPRS connection.



① When the GPS data has expired, the relevant message displays on the top of the screen.

① The icon reminds you that your GPS data has expired.

② Tap the **Notification** Button to open the message window.

③ Tap to close the message window.

Location SMS

Tap , **Programs**, **GPS**, and then **Location SMS**.

You can utilize the GPS function offered by your Pocket PC, to send the matching location automatically found by this program and the necessary message to your contacts. This could be helpful in preventing kidnapping, reporting disastrous situations, calling for help in emergencies or locating an individual. In addition, we have formulated many SMS templates based on different situations for your convenience.

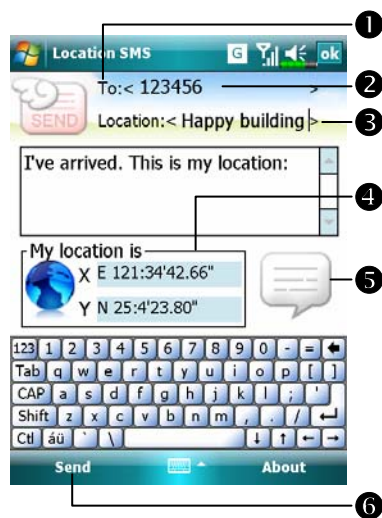

1. It is better to execute this program at a location with clear signal.

1 Tap to open the **Contacts** screen, if set up in advance, you can choose contacts directly.

2 You can directly enter mobile phone number in the **To** area. If there is more than one recipient, please use “;” to separate recipients.

3 You can directly enter your message in this area, such as landmarks, features or street names.

4 Automatically searches for GPS information.

5 Tap to allow you to select, add, edit, or delete your most used messages.

6 Tap to allow you to send SMS messages and report your location.

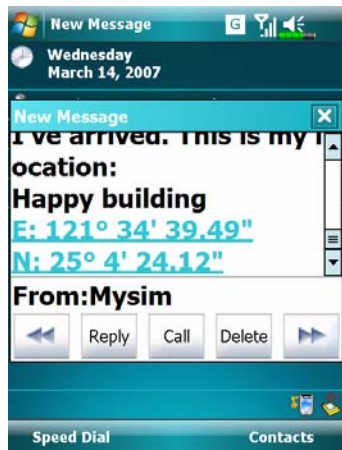

2. Select  in the main screen, once in the screen shown on the left, tap on any message and tap **OK** Button to select.

Further, by pressing and holding anywhere on the screen, together with the pop-up menu, you can add, edit or delete your most used messages.

3. The content of the message that your recipient views looks similar to what is shown on the left. Actual messages differ depending on the recipient's device.

GPS Viewer

Tap , **Programs**, **GPS**, and then **GPS Viewer**.

You may use this Pocket PC to automatically search the GPS coordinates of your location and check if the GPS functions work properly.



1. Run this program in a location with good signal reception.

① Greenwich Mean Time (GMT): After connecting to a satellite and obtaining the GMT, it will be displayed on the screen.

Tap to set the satellite time as the system time.

② Report GPS tracking information.

③ Tap to change the unit.

④ Switch to Satellite mode.

2. Tap **Satellite** to switch to Satellite mode.

① Red: Satellite detected (In View).

Blue: Satellite data detected (Data Valid).

Green: Tracking completed (Tracker).

② Signal strength: The larger the figures, the stronger the signal.

③ Satellite ID: The IDs expressed in numbers in this field correspond to the IDs on the earth image above.

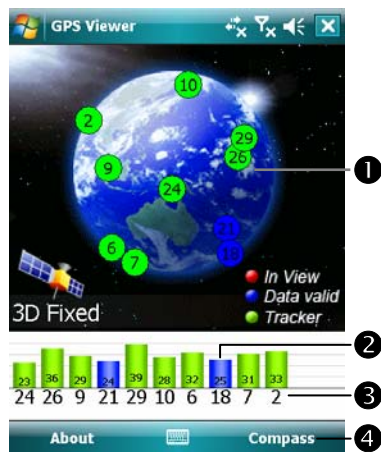

④ Switch to Compass mode.



4 Using the Phone /

The Phone feature on the Pocket PC allows you to perform the following tasks:

- Make and receive calls.
- Quickly make calls or listen to voice mail without entering phone numbers using **Contacts**, **Speed Dial**, or your **Call Log**.
- Check the **Call Log** to see who has called, whom you have called, add a new number to **Contacts**, and access notes taken while you were on a call.
- Receive calls and easily take notes during the call.
- Send SMS messages.
- Customize how your phone rings.

To switch to the Phone function, press the  button on the lower part of the Pocket PC or tap  and then **Phone**.

Caution!

- To avoid distraction and affecting driving safety, never use your Pocket PC while driving an automobile or any other moving vehicle.
- Make sure that the SIM card is properly installed in your Pocket PC and the Phone is already turned on before you use the functions described in this section.
- When you are on a plane, in a medical facility or at a gas station where wireless communications devices are not allowed and must be turned off, please go to **Wireless Manager** and select the **ALL OFF** Button to turn off your Pocket PC's mobile phone, Bluetooth, and wireless LAN functions. By pressing the "Power Button" of the Pocket PC, you only turn off the display.
- The Phone function relies on the Pocket PC main battery for power. Maintain the main battery power level to assure call quality and the normal operation.

Installing and Removing the SIM Card

- 1 Insert the SIM card into the SIM card slot with its golden contacts facing down. Follow the picture indicated on the Pocket PC.
- 2 Main battery
- 3 Back cover
- 4 Follow the direction in the picture to install the main battery.
- 5 Main battery lock

■ Installing the SIM Card

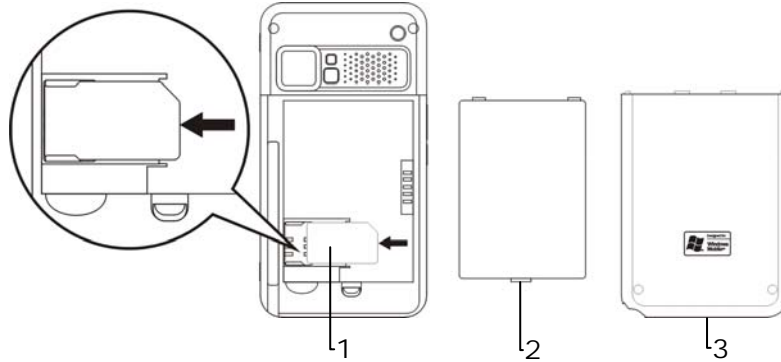

■ Installing the Battery

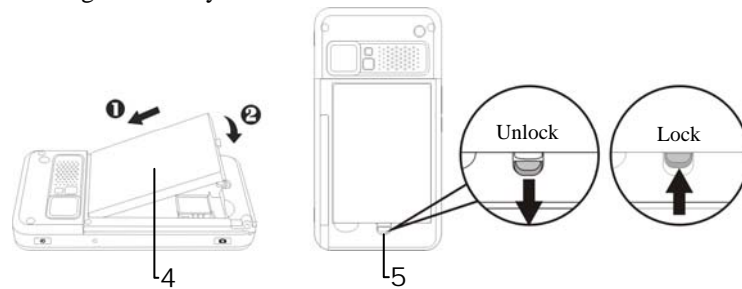

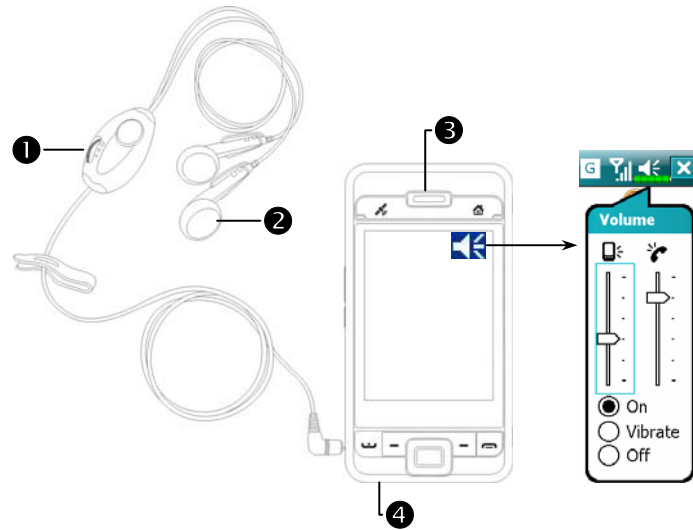

1. Tap the **ALL OFF** Button in **Wireless Manager** to turn off your Pocket PC's mobile phone, Bluetooth, and wireless LAN functions.
2. Press the "Power Button" of the Pocket PC to turn off the screen.
3. Remove the back cover, unlock the main battery lock and remove the battery.
4. Insert the SIM card into the SIM card slot with the golden contacts facing down. Use according to the picture labelled on the Pocket PC.
Or remove the SIM card horizontally.
5. Reinstall the main battery and then lock the main battery lock.
6. Slide the back cover into the groove, and reinstall the back cover.

Using the Phone















- 1** Microphone **2** Earphone
3 Phone Speaker **4** Phone Microphone (Bottom of Pocket PC)

Combination Method	Operation	Answer or End a Call	Adjust Earphone Volume
Hold the Pocket PC manually for calls	Hold the Pocket PC and position the speaker close to your ear and the microphone close to your lips.	Press  Send Button or  End Button on the lower part of the Pocket PC.	While answering a call, push the volume control key on the side of the Pocket PC to test the earphone volume.
Install the external headset	Place the earphone in your ear and position the microphone to your lips.	Use the line control function. Press the button on the headset to answer or end the call. Except the Bluetooth headset, when the phone is ringing, hold down the button to reject the incoming call.	Use the knob on the headset to adjust the volume of the earphone during a call.

Adjusting the Phone Volume



Tap  on the top and adjust all programs' sound functions under . Adjust the phone sound volume under .

1. When there is no call, you can push the volume control key on the side of the Pocket PC or use the stylus to tap the speaker icon . Tap  and then  to adjust the ring volume of the incoming call.
2. Push the volume control key on the side of the Pocket PC or tap  and then  to adjust the phone volume. You can only do this during a call.
3. Vibration mode: The speaker icon  on the top changes to .
4. Mute mode: The speaker icon  on the top changes to .

Here is how to adjust the proper volume:



1. If earphones are used with the Pocket PC to make calls, set the volume according to actual personal needs.
2. If earphones are not used with the Pocket PC and not held close to the ear for calls but similar to hands-free operation, it is recommended to set the sound volume for the top two levels.
3. For holding the Pocket PC close to the ear directly for calls, it is recommended that you set the volume to the lower four levels. It is recommended not to use the top two levels because the volume is high and may affect your hearing.

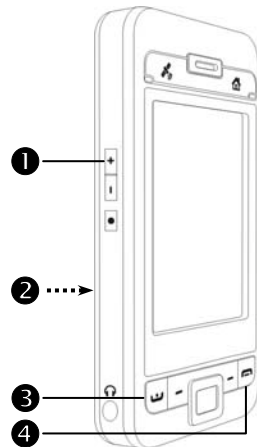

Turn on or turn off the speakerphone:

1. Enable the speakerphone: While answering a call, tap **Speaker on** to turn on.
2. Disable the speakerphone: Tap **Speaker off** to turn off.





Turning the Phone On or Off and Making Calls













- ① Adjust earphone volume
- ② Rear side: The SIM card is located below the battery.
- ③  Send Button
- ④  End Button

1. Open the Pocket PC back cover and remove the main battery.
2. Install the SIM card properly. As shown in the direction on the Pocket PC, pay attention to the position of the cut corner on the SIM card when you insert it into the card slot. The golden contacts of the SIM card should face down.
3. Reinstall the main battery and the back cover properly.
4. Turn on the phone: Tap the  icon. When the message window appears, tap “Turn off flight mode,” and input the PIN and wait for the phone to turn on. The  icon changes to .



5. Dial: Press  to enter the Phone screen. Use the stylus to tap the telephone number and then tap the **Enter** Button.
6. Answer a call: Press .
7. End a call: Press .
8. Turn off the phone: Tap the  icon. When the message window appears, tap “Turn on flight mode.”

The following table shows the icons that you may see on the Navigation Bar on the top of the screen.

Signal Indicator	Description
	SIM card unavailable.
	The phone is turned off. To turn it on, tap this icon.
	Network is searching or unavailable.
	Phone connection unavailable or network error. To turn it off, tap this icon.
	The phone is turned on and signal reception is normal. To turn it off, tap this icon.
	Active call. To switch back from other programs, tap this icon.
	Call forwarding active
	Calls are forwarded
	Missed call
	Roaming mode

Toolbar



- 1 Smart Dialing: Enter the portion you remember and the system will use the fuzzy comparison method to list the matching contacts at area 2 on the figure.

Please refer to the keyboard shown on the screen to enter information including the phone number and letters.

- 2 Tap a contact to view contents.
- 3 Provides the relevant menu. For example, select **Options** to change the phone setup such as ring tone, vibration mode, PIN code, etc. Or select **Send Text Message** to send SMS message.
- 4 **Hide Keyboard** Button: Tap to expand the contacts display area, and then tap **Keyboard** Button to restore the keyboard.
- 5 **Speaker on** Button: While answering a call, tap to enable the speakerphone.
- 6 **Keypad** Button: Tap to return to the keypad.



Call from Contacts

Phone numbers entered in Contacts can be used to quickly locate phone numbers and make calls.

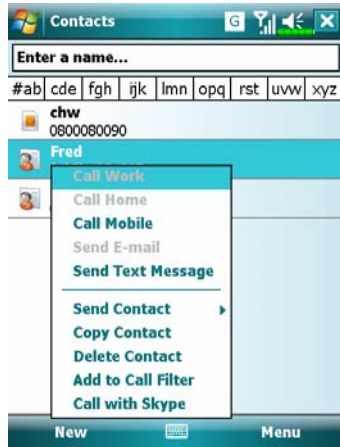

1. In the contact list, tap and hold the contact to display a pop-up menu.
2. Tap **Call Mobile** or **Call Work** on the pop-up menu.
3. Tap a contact to display the details.

Call from Speed Dial

On the Phone screen, tap **Speed Dial** Button to enter the following screen.



- 1 Tap and hold on a certain contact. The pop-up menu provides the **Delete** and **Edit** options for phone setup.
- 2 Tap to redial this number. Remember that this code (for example, "2") you want to dial can also be dialed from the number area in the Phone screen by tapping on "2".
- 3 Tap **Menu** and then **New** to show the Contacts list. Tapping a Contacts name and number will add it to the Speed Dial list. A maximum of 99 numbers are allowed.

Call from the Call History

Tap **Call History** Button on the Phone screen to enter the following screen.

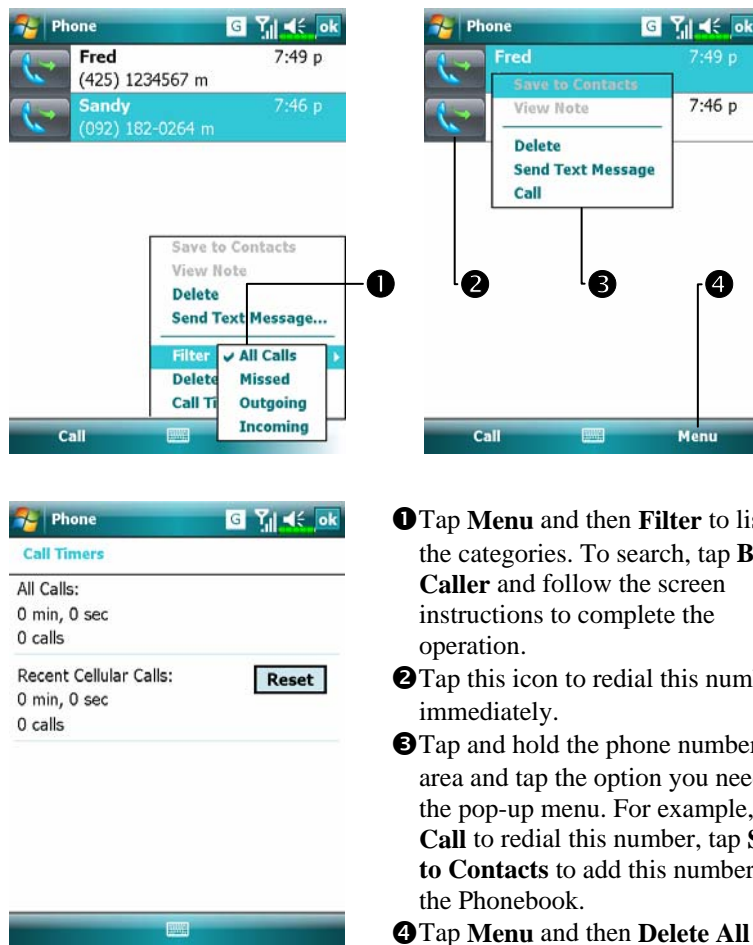

- 1 Tap **Menu** and then **Filter** to list the categories. To search, tap **By Caller** and follow the screen instructions to complete the operation.
- 2 Tap this icon to redial this number immediately.
- 3 Tap and hold the phone number area and tap the option you need on the pop-up menu. For example, tap **Call** to redial this number, tap **Save to Contacts** to add this number to the Phonebook.
- 4 Tap **Menu** and then **Delete All Calls** to delete all call records. Or tap **Call Timers** to view the number of calls, call time and manage call records as shown in the figure on the left.

Customize Your Phone

Tap **Menu, Options**, and then the **Phone, Services, Network, Skin, Appreciation software** or **Others** tabs to modify the relevant service setup. Note that the setup values you can change here depend on the services provided by your telephone company.

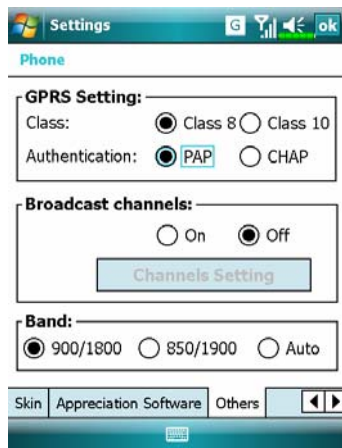

Tap the **Appreciation software** tab.

- 1 Make sure that you have checked “SMS Zoom.” When you receive an SMS, a large mail icon will appear on the upper right of the Today screen, and you can open your newly received message by tapping on this icon.
- 2 If you check “Call Filter” and “Scenarios,” the representing icons will appear on the lower right of the Today screen.

Tap the **Others** tab.

- 1 **GPRS Setting:** You can set the option for GPRS connection.
- 2 **Broadcast Channels:** If your telephone company provides this service, you can activate it.
- 3 **Band:** You can set the band for different regions.

Tap **Menu**, **Options**, and then the **Phone** tab.



- 1 You can set the ring type as ring, vibration or mute.
- 2 If you want to use a customized ring tone file, use the synchronization program on your desktop computer to copy the .wav ring tone file to the /Windows/Rings folder on the Pocket PC. You can then select this ring tone from the Ring tone list.
- 3 Set the key sound for dialing.
- 4 You can set a PIN (Personal Identity Number) to block unauthorized access to your phone. Your first PIN is provided by your phone service provider.

Add Ringtone

Tap **Menu**, **Programs**, **Phone**, and then **Add Ringtone**.



1. All of the music files stored in your Pocket PC or storage card will be listed, please select the new ringtones which you would like to add.
2. Tap **Add Ringtone** Button, then you can enter the **Phone** tab for telephone environment settings and select your ringtone files from the Ring tone list.

Phone Application Programs

⚠ Caution!

Before you can use the functions described in the **Phone** Group. Make sure that the SIM card is properly installed in your Pocket PC and the Phone is already turned on.

SIM Manager

If your Pocket PC does not include this function, it means it is not supported and you can skip this chapter.

Tap , **Programs**, **Phone**, and then **SIM Manager**.

Standard Display

SIM Manager manages the SIM Phonebook and duplicates the Phonebook entries.

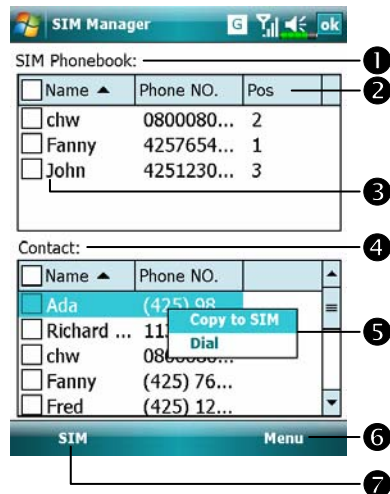

1 SIM Phonebook

2 **Name or Pos.:** Tap on the title of the columns, and when the ▲▼ button appears it is possible to sort.

3 Tap and hold a Phonebook entry to duplicate it to **Contacts**.

4 **Contacts:** The contact's mobile number will be displayed in this column. If none is available, then the office number will be displayed.

5 Tap and hold a Contacts entry to duplicate it to the **SIM Phonebook**.

The following are the shared functions for standard screen or fullscreen display:

- ⑥ **Menu Button:** Provides the appropriate function table.
- **SMS Management:** Enter the SMS management screen.
- **New SIM Contact:** Add a new phonebook entry to the SIM card.
- **Refresh:** Tap to refresh the displayed contacts and SIM card information, after the Contacts are updated.
- ⑦ **Standard Button:** Provides **Standard, SIM, Contacts** three switching modes.

Full-Screen Display

When switching to fullscreen display, the fullscreen display for SIM card phonebook or Contacts will be as shown as per the illustration below. This will enable the phonebook contacts to be easier to read and more precise management can be conveniently performed.

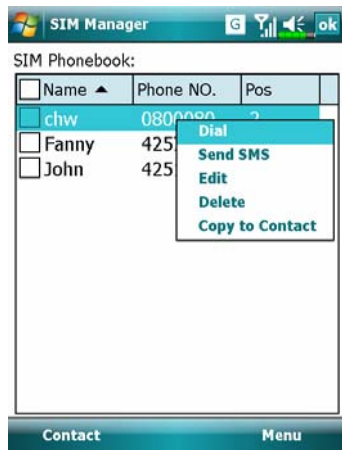

1. Tap and hold a Phonebook entry.
Then, tap **Dial** on the pop-up menu to call this contact.
2. Choose **Send SMS** from the list, to enter the preparation screen for sending SMS.
3. Tap and hold a Phonebook entry to be duplicated. Then, tap **Copy to Contacts** on the pop-up menu to copy to **Contacts**.

Copy Phonebook Information

The function descriptions of this section are for standard screen and fullscreen display. Copying phonebook information between the SIM card and Contacts is either by “select one, select multiple, or select all” methods. For precise management of your phonebook that can be conveniently performed.

■ Select all

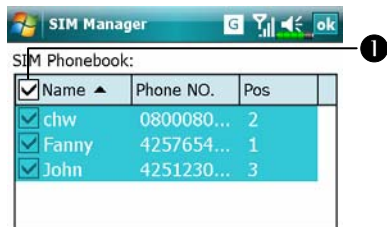

1 Tap on the in the title to select all.

2 Tap on the in front of a phonebook data entry to select this single entry.

3 It is also possible to select multiple phonebook data entries.

4 In the **SIM Phonebook** area, tap and hold the selected phonebook data to select the function and copy to **Contacts**.

5 In the **Contacts** area, tap and hold the selected phonebook data to select the function and copy to **SIM Phonebook**.

■ Select one

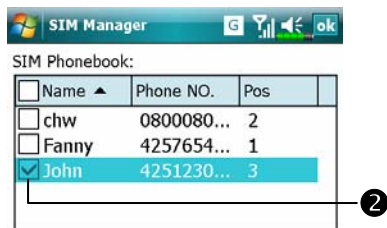

■ Select multiple

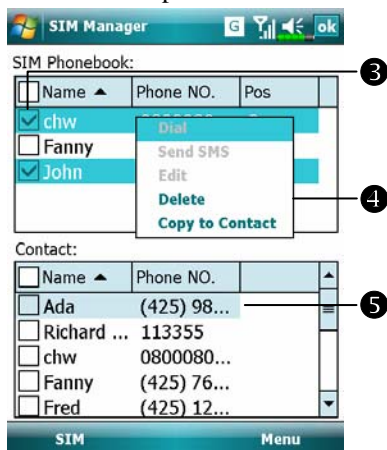

SMS Management

Tap **Menu** and then **SMS Management** to enter the SMS management screen and to display the original SMS contents on the SIM card.

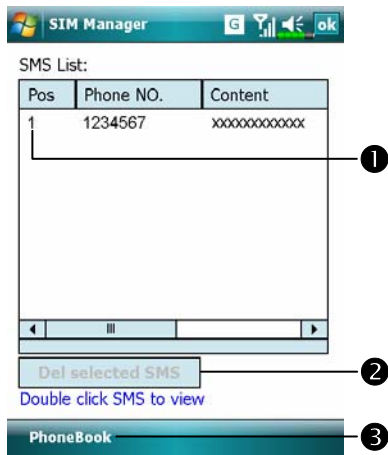

- ① Double tap the number in the **Pos.** column to view the corresponding SMS contents.
- ② Tap the SMS you want to delete. When it is highlighted, tap **Del selected SMS** Button to delete this message from the SIM card.
- ③ Return to the **SIM Manager** screen.

SIM Tool Kit

Tap , **Programs**, and then **SimTKUI** (SIM Tool Kit).

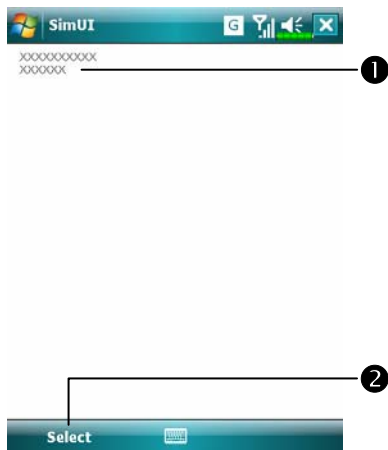

- ☺ This screen is for reference only. The actual screen is based on the service items provided by your telecom company.
- ① Tap any service item.
- ② **Select** Button: Launch service item. Follow the screen or voice instructions.

SMS Sender

Tap  **Programs, Phone**, and then **SMS Sender**.

Tap , **Messaging**, and then **New**.

Press  to bring up the **Phone** screen. Tap **Menu** and then **Send Text Message**.

Enter the composing SMS screen in **Messaging**.

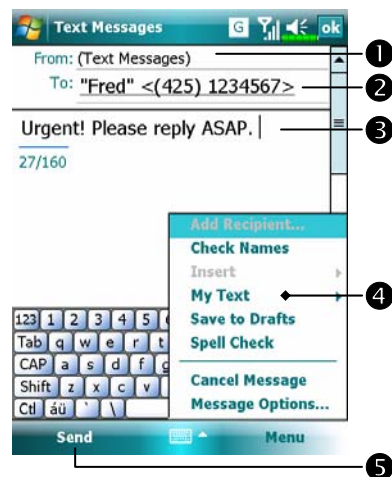

- 1 "Text Messages" means you are editing SMS.
- 2 Input the mobile phone number.
- 3 Input the messages you want to send.
- 4 Tap **Menu** and then **My Text** to select canned messages or to edit your Text Messages.
- 5 Tap to send SMS message.

Speed Dial

Tap  **Programs, Phone, and then Speed Dial.**

Hot Key Switch

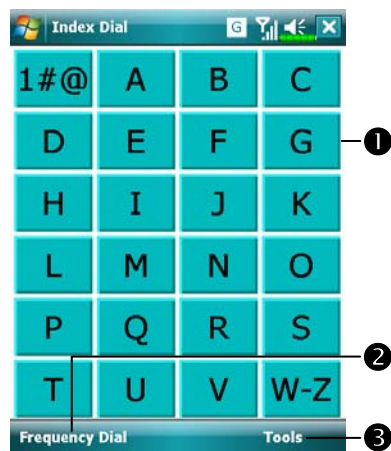

- 1 Tap the box according to the functions provided by the system.
- 2 Tap to switch between these functions: **Frequency Dial** → **Index Dial**.
- 3 **Tools** Button: Provides the relevant menu. For example, select **Settings** to set the interface as **Frequency Dial** or **Index Dial**. Select **Sound on/off** to set the sound for tapping the screen.

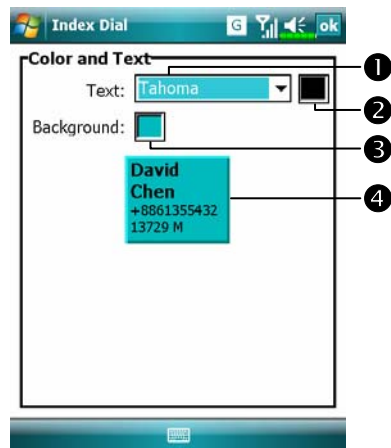

- 1 Tap **Tools** and then **Color and Text** to enter the Setting screen shown on the left. You can set the text font, text color and button background color according to your personal preferences.

- 1 Font
- 2 Text color
- 3 Button background
- 4 Preview area

Frequently Dialed Screen

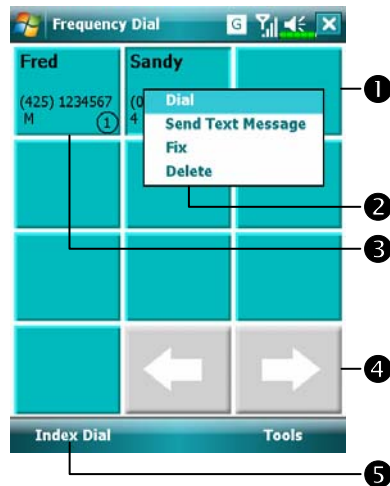

☰ Frequency Dial screen

- 1 Tap any phone entry box to speed dial.
- 2 Tap and hold the box, then select appropriate command from the pop-up menu.
- 3 Sort according to the number of calls in descending order. The upper left corner has the most number of calls while the lower right corner has the least number.
- 4 ◀ ▶: Tap to view the previous or next page.
- 5 Tap to switch to the **Frequency Dial** screen as shown on the left.

Index Dial

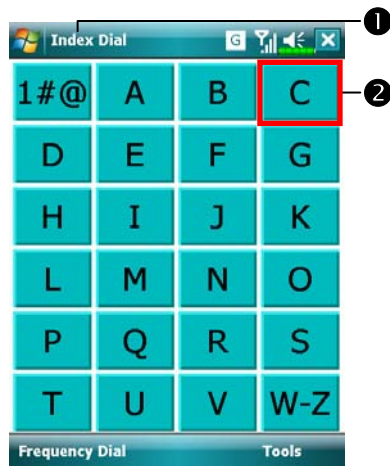

☰ Index Dial screen

- 1 Switch to the Index Dial screen as shown on the left.
- 2 Tap on any letters. The content displayed are the data created in **Contacts**. If you did not create any data in Contacts, the screen is blank.

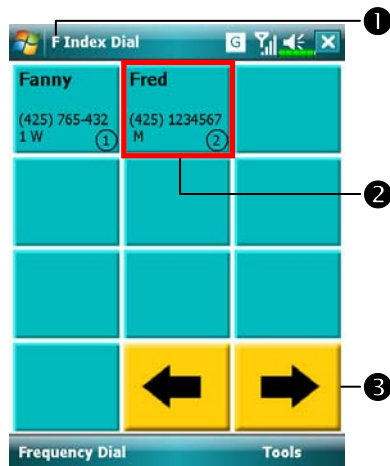







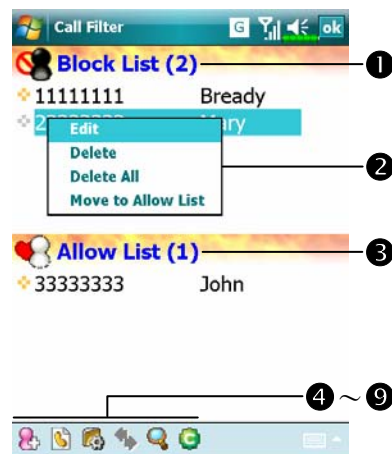

- 1 The letter "F" appears on the upper left side of the screen (see left). This indicates that this page contains all address data that starts with "F". The English Address Book is arranged alphabetically using the First Name.
- 2 Tap any box to speed dial.
- 3 ☐☐: Tap to view the previous or next page.

Call Filter

Tap  **Programs, Phone,** and then **Call Filter.**



- 1 Tap  **Add New List** Button to add a new Block List.
- 2 Tap and hold an entry in the list. Select from the pop-up menu to manage the list according to your needs.
- 3 Tap  **Add New List** to add a new Allow List.
- 4 Tap and hold any entry in the list to display the pop-up menu.
- 4  **Add New List** Button
- 5  **Call History** Button: Blocked call records.
- 6  **Options** Button
- 7  **Synchronize** Button: Tap **Options** and then **Synchronize** to activate the functions for this button. The system will synchronize the names according to the current Contacts entries but without updating the phone numbers.
- 8  **Find** Button: Helps you find entries conveniently if there are lots of entries in the list.
- 9  **About** Button: Information about **Call Filter**.







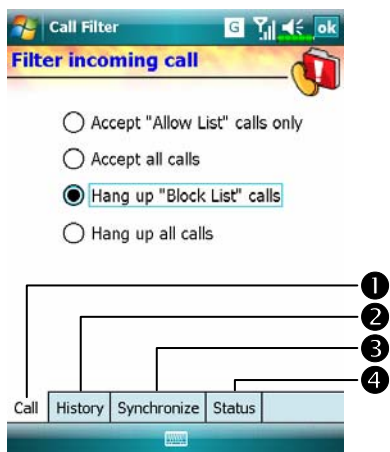

Tap  **Add New List** Button in the **Call Filter** screen to enter the screen shown on the left.





- 1 Input name and telephone number.
- 2 Add to Block List or Allow List.
- 3 OK Button
- 4 Cancel Button

Tap and hold a contact in the **Contacts** screen. Select **Add to Call Filter** from the pop-up menu to add a new entry to the Block List.



Tap  **Options** Button in the **Call Filter** screen to enter the screen shown on the left.

- 1 **Call** tab: Set to accept or reject call.
- 2 **History** tab: Set the time for keeping the record.
- 3 **Synchronize** tab: Activate or deactivate the functions of  **Synchronize** Button in the **Call Filter** screen.
- 4 **Status** tab: Set to activate or deactivate the Status icon on the lower right of the Today screen. If activated, the icons    or  will show. Tap to view the filter status.

Tap the icon    or  on the lower right of the Today screen to display the **Call Filter** Status window.

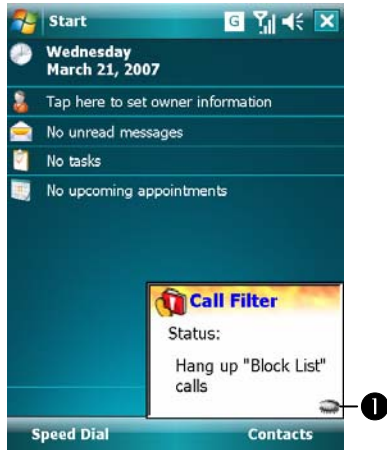

Display **Call Filter** setting status.

Tap to hide the **Call Filter** Status window.

5 Customize Your Pocket PC /

You can adjust the Pocket PC settings according to your personal preferences and install other programs.

Adjusting Settings

To see available options, tap , **Settings**, then the **Personal** or **System** tab located at the bottom of the screen. The following utilities allow you to adjust the settings based on your personal work style.

- **Clock & Alarms**, to change the time or to set alarms
- **Menus**, to customize what appears on the  menu, and to enable a pop-up menu from the **New** button
- **Owner Information**, to enter your contact information
- **Lock**, to limit access to your Pocket PC
- **Power**, to maximize battery life
- **Today**, to customize the look and the information that is displayed on the Today screen

Notifications

Your Pocket PC reminds you in a variety of ways when you have something to do. For example, if you've set up an appointment in **Calendar**, a task with a due date in **Tasks**, or an alarm in **Clock & Alarms**, you'll be notified in any of the following ways:

- A message box appears on the screen.
- A sound, which you can specify, is played.
- A light flashes on your Pocket PC.
- The Pocket PC vibrates.

To choose reminder types and sounds for your Pocket PC, tap  and then **Settings**. In the **Personal** tab, tap **Sounds & Notifications**. The options you choose here apply throughout the Pocket PC.

Power Preference Settings

Tap , **Settings**, the **System** tab, and then **Power**.

View the power usage condition or perform the relevant power management settings.

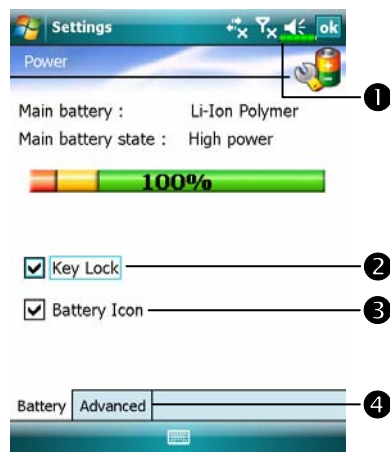

- 1 Power icon
- 2 Check this item, so that when you accidentally press the hardware buttons on the Pocket PC, the Pocket PC will not exit the sleep mode. This will prevent unnecessary power consumption if a button is being pressed accidentally and not being discovered in time.
- 3 Checking this item displays the power icon on the upper right side of the screen.
- 4 **Advanced** tab: Set the Pocket PC to turn off automatically after a period of inactivity.

Backlight

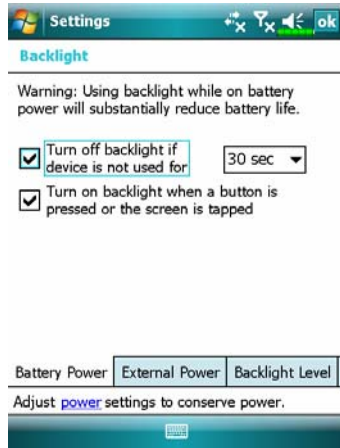

Tap , **Settings**, the **System** tab, and then **Backlight**.

1. **Battery Power** or **External Power** tab: Set the relevant backlight functions.
2. **Backlight Level** tab: Adjust the backlight level.

Microphone

Profile	Microphone	Cause
* Voice Commander voice control	Turn the volume down and find the proper volume setting for better recognition of system.	Surrounding interference recorded when volume up.
Speech recording	Turn the volume up.	More distance from the lecturer more interference recorded.

▣ * Used for the version built in “Voice Commander.”

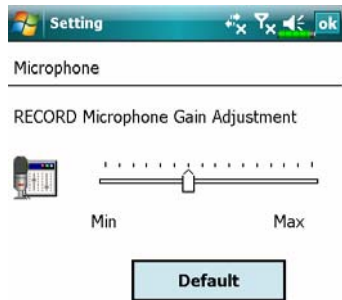



Tap , **Settings**, the **System** tab, and then **Microphone**.

1. Use the slider to adjust volume of the recording mic.
2. **Default** Button: Restore to default system settings.







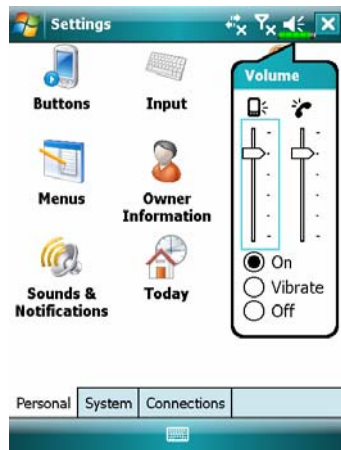

▣ This document lists the functions, specifications, and illustrations for reference only. The actual purchased product should be taken as the standard.

Adjust Volume

Push the volume control key on the side of the Pocket PC. Or use the stylus to tap the  icon on the top of the screen to adjust all program sound functions under . Adjust the phone volume under .



1. **Adjust volume:** When set to **On**, use the stylus to tap and drag the slider up and down to adjust the volume. You can also push  or  on the side of the Pocket PC.
2. **Vibrate:** Under **Vibrate** mode, the sound function of all programs will be replaced by vibration, including incoming call rings. The  icon on the top changes to .
3. **Mute:** Under **Off** mode, the sound function of all programs will be turned off, including incoming call rings. The  icon on the top changes to .

Scenarios

Tap , , **Programs, Phone**, and then **Scenarios**.

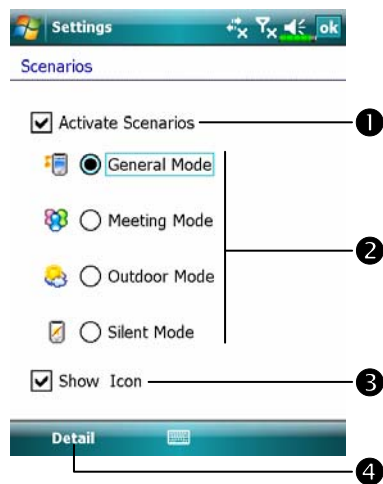

You can tap any **Scenarios** icon  in the Today screen to enter **Scenarios**. After selecting a mode, this will become the **Scenarios** icon you selected.

- 1 Check this item to activate **Scenarios**.
- 2 Select an applicable mode.
- 3 Check this item to display the **Scenarios** mode icon in the Today screen.

4 **Details** Button: Set the relevant options for this mode, such as volume, backlight, etc.

Tap **Details** Button to enter the screen shown on the left. And then tap **Settings** Button to set the relevant options for this mode, such as volume, backlight, etc.

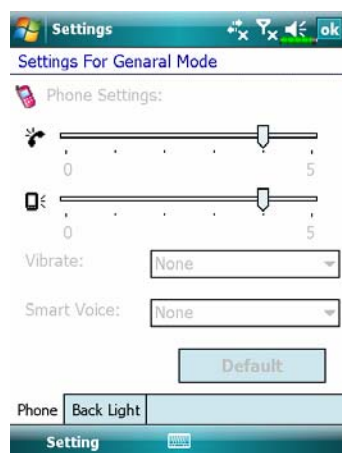

Quick Link

Tap , **Settings**, the **Personal** tab, **Today**, the **Items** tab, and then check **Quick Link**.

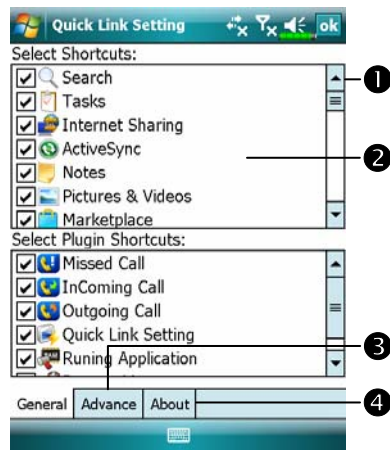

① **Items** tab: Enter the Today setting screen with **Quick Link** Options.

② Make sure that **Quick Link** is checked so that the Today screen can display this item.

③ **Options** Button: Check and select **Quick Link** to highlight it, and then tap **Options** to enter its settings screen.

④ Tap **Move Up** or **Move Down** to arrange the display order of these items in the Today screen.

☰ Tap **Options** in the above screen to enter the screen shown on the left.

① Use the scroll bar to view pages.

② **General** tab: Program names that are checked will be displayed in the Today screen. Tap again to deselect an item and it will not be displayed in the Today screen.

③ **Advanced** tab: Enter the Quick Link Advanced Settings screen.

④ **About** tab: Relevant information about **Quick Link**.

☑ You can select a maximum of 27 icons. Items not supported by the system will not display.

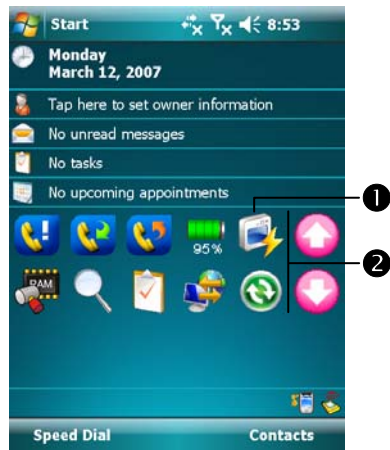
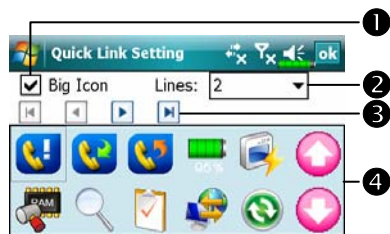

Tap the **Advanced** tab to enter the screen shown on the left.

Set to enable or disable the use of the Big Icon.

Tap on arrowhead to select the number of lines for displaying **Quick Link**.

The icons of the programs you checked in the **General** tab are displayed in this area.

Tap an item in **3** area, and use the arrows here to arrange order in which the item will be displayed in the Today screen.

Description on the Today Screen

Tap this icon to link to **Quick Link** settings screen.

Your Quick Link settings. Tap the icon to quick link to this program.

Find and Organize Information

The **Search** feature on your Pocket PC helps you quickly locate information.



1. Tap , **Programs**, and then **Search**. Input the text you want to find and then select the data type. Tap on **Search** to start the search.
2. To find information that occupies a larger space, select **Larger than 64 KB** for **Type**.

Actually, you can use **File Explorer** to search for files and place these files into folders systematically. Just tap , **Programs**, and then **File Explorer**.



- 1 Tap to change folders.
- 2 Select the sort order for the list.
- 3 Tap the folder name to open folder.
- 4 Tap **Menu** and then **New Folder** to create a new folder.

▣ You can move files in **File Explorer** by tapping and holding the item you want to move, and then tapping **Cut** or **Copy** and **Paste** on the pop-up menu.

Navigation Bar and Command Bar

The navigation bar is located at the top of the screen. It displays the active program and current time, and allows you to switch to programs and close screens.

Use the command bar at the bottom of the screen to perform tasks in programs. The command bar includes menu names, buttons, and the Input Panel button. To create a new item in the current program, tap **New**. To see the name of a button, tap and hold the stylus on the button. Drag the stylus off the button so that the command is not carried out.

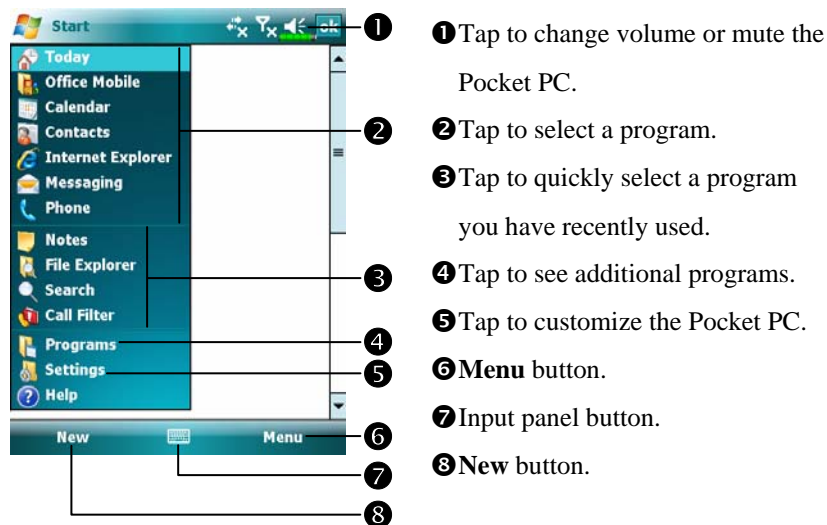

Pop-up menus

With pop-up menus, you can quickly choose an action for an item. For example, you can use the pop-up menu in the contact list to quickly delete a contact, make a copy of a contact, or send an e-mail message to a contact. The actions in the pop-up menu vary from program to program. To access a pop-up menu, tap and hold the stylus on the item name that you want to perform the action on. When the menu appears, lift the stylus, and tap the action you want to perform. Or tap anywhere outside the menu to close the menu without performing an action.

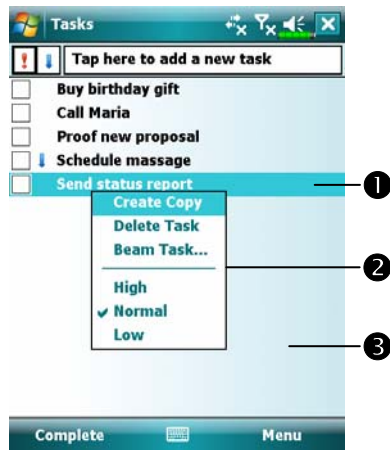



- 1 Tap and hold to display the pop-up menu.
- 2 Lift the stylus and tap the action you want.
- 3 Tap outside the menu to close it without performing an action.

Redefine Hot Keys

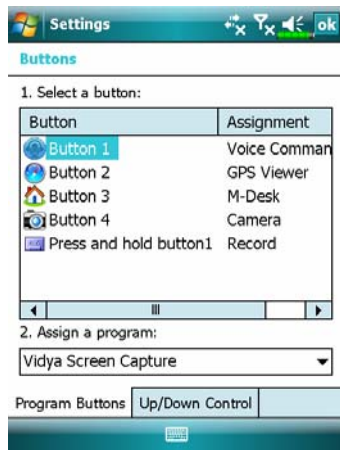
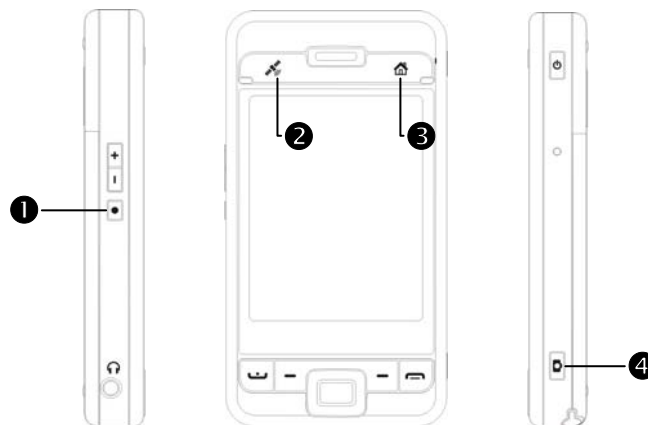
Tap , **Settings**, the **Personal** tab, and then **Buttons**.



These hot keys can be redefined as launch keys for frequently used programs.

 End Button and  Send Button are exclusive phone functions so they cannot be redefined.

6 Synchronization /

Windows Vista Part

A PC with Windows Vista™ operating system can be used to enable connection and synchronize with your Pocket PC. The Windows Mobile® Device Center application can be used to manage your Pocket PC, and can provide Pocket PC access to other resources through the connected PC. The online services and application access can also keep the Pocket PC up-to-date with the connected PC. For example, if you make a modification to the Pocket PC, then this modification will be automatically applied to the appropriate information on the computer during the next synchronization, and vice versa. This way, the latest data can be ensured to be available no matter which computer is being accessed.

♥ Important Installation Notice

Before you install Windows Mobile® Device Center, make sure that the USB cable on the Pocket PC is not connected to the personal computer. Connect the USB cable only after Windows Mobile® Device Center is installed.

1. **Software installation:** You could use the Getting Started CD to install Windows Mobile® Device Center on the personal computer.

2. Hardware installation: The USB cable is a plug-and-play device. Use the USB cable to connect your Pocket PC to your personal computer.

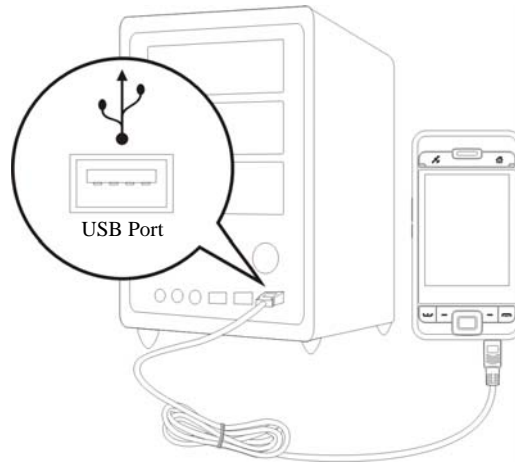

3. Using Windows Mobile® Device Center

- ❶ After installation is complete, the Setup Wizard helps you customize your synchronization settings.
- ❷ Once you use the USB cable to connect the two devices properly, the Set Up a Partnership screen appears on the personal computer. Set it up according to your requirements. The green icon  appears on the status bar of your personal computer to indicate that it is Connected.

Windows XP/2000/98 Part

A PC with Windows XP/2000/98 operating system can be used to enable connection and synchronize with your Pocket PC. Using Microsoft® ActiveSync®, you can *synchronize* the information on your desktop computer with the information on your device. Synchronization compares the data on your device with your desktop computer and updates both computers with the most recent information. For example:

- Keep Pocket Outlook data up-to-date by synchronizing your Pocket PC with Microsoft Outlook data on your desktop computer.
- Synchronize Microsoft Word and Microsoft Excel files between your Pocket PC and desktop computer. Your files are automatically converted to the correct format.
- By default, ActiveSync does not automatically synchronize all types of information. Use ActiveSync options to turn synchronization on and off for specific information type.

With ActiveSync, you can also:

- Back up and restore your Pocket PC data.
- Copy (rather than synchronize) files between your device and desktop computer.
- Control when synchronization occurs by selecting a synchronization mode. For example, you can synchronize continually while connected to your desktop computer or only when you choose the synchronize command.
- Select which information types are synchronized and control how much data is synchronized. For example, you can choose how many weeks of past appointments you want synchronized.

Installing and Using ActiveSync

♥ Important Installation Notice

Before you install ActiveSync, make sure that the USB cable on the Pocket PC is not connected to the personal computer. Connect the USB cable only after ActiveSync is installed.

1. **Installing ActiveSync:** You could use the Getting Started CD to install Microsoft ActiveSync version 4.5 or above on the personal computer. ActiveSync is already installed on your Pocket PC.
2. **Hardware installation:** The USB cable is a plug-and-play device. Use the USB cable to connect your Pocket PC to your personal computer.

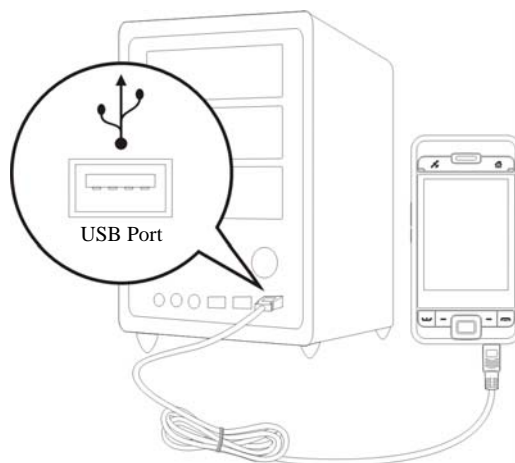

3. Using ActiveSync

- ➊ After installation is complete, the ActiveSync Setup Wizard helps you customize your synchronization settings.
- ➋ Once you use the USB cable to connect the two devices properly, the Set Up a Partnership screen appears on the personal computer. Set it up according to your requirements. The green icon  appears on the status bar of your personal computer to indicate that it is Connected.
- ➌ Click **Explore** on the Microsoft ActiveSync on the personal computer to access files in the Pocket PC. Just like using a personal computer, manage the files in the two devices.

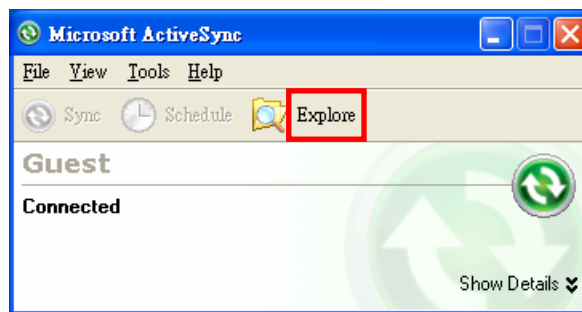

FAQ About Synchronization

Tap , **Settings**, the **Connections** tab, and then **USB to PC**.

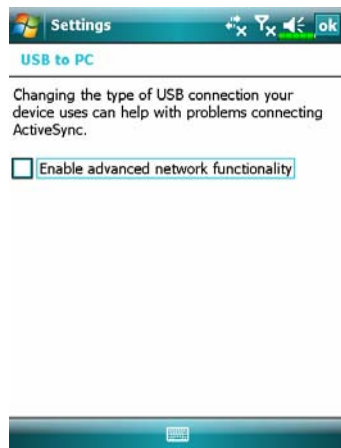

1. Factory setting defaults to checking the box.
2. If you have followed the above installation and operation procedures and find that the connection between your Pocket PC and desktop PC still cannot be established, please uncheck the box shown on the left.

USB Synchronization

Before you start to synchronize, use the Pocket PC Getting Started CD to install synchronization tools on your personal computer. For more information on how to install, please refer to the Pocket PC Getting Started CD or online help. Synchronization tool is already installed on your Pocket PC.

ActiveSync synchronization settings:

1. After installation is complete, the Setup Wizard will continue to guide you. Adjust the specifications according to your actual needs.
2. Use the USB cable to connect the two devices properly and the Set Up a Partnership screen appears on the personal computer. Set it up according to your requirements.



1 Click OK.

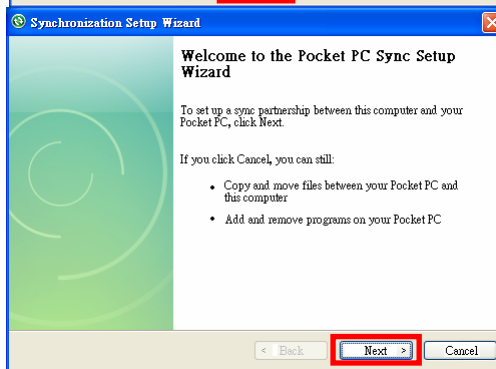

2 Click Next.

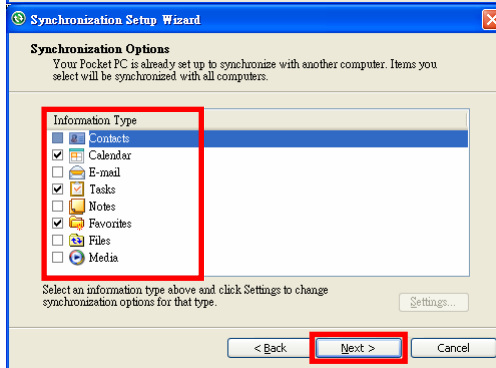

3 Check the items you want to synchronize.

4 Click Next.

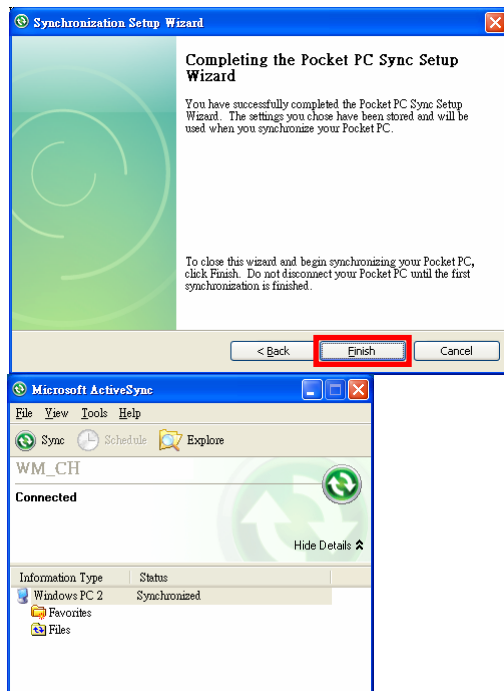



5 Click **Finish**.

- 6 After installation is complete, the ActiveSync Setup Wizard helps you connect your Pocket PC to your desktop computer, set up a partnership so you can synchronize information between your Pocket PC and your desktop computer, and customize your synchronization settings. Your first synchronization process will automatically begin when you finish using the wizard.
- 7 The green icon  appears on the status bar of the personal computer to indicate that it is Connected.

After your first synchronization, take a look at **Calendar**, **Contacts**, and **Tasks** on your Pocket PC. You'll notice that information you've stored in Microsoft Outlook on your desktop computer has been copied to your device, and you didn't have to type a word. Disconnect your Pocket PC from your computer and you're ready to go!

Synchronization Tool on Pocket PC

Once you have set up **ActiveSync** and completed the first synchronization process, you can initiate synchronization from your Pocket PC. To switch to **ActiveSync** on your Pocket PC, tap , and then tap **ActiveSync**.

For more information on how to use **ActiveSync** on your personal computer, run **ActiveSync** and refer to the **ActiveSync** online help. To learn more about the Pocket PC **ActiveSync**, switch to **ActiveSync** and tap  and then **Help**. Just refer to the **Help** for more information.

After the synchronization is completed, tap **Calendar**, **Contacts**, and **Tasks** on the Pocket PC to view if the information saved in Microsoft Outlook on the personal computer is already copied to the Pocket PC.

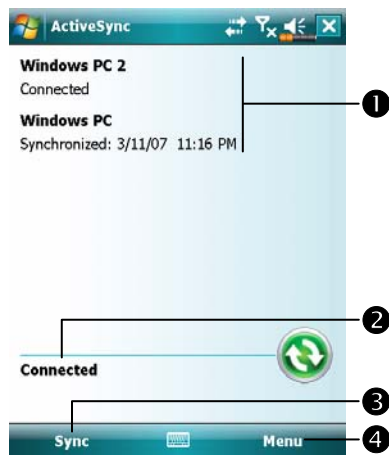

On the Pocket PC site: Tap , **Programs** and then **ActiveSync**.

- 1 View synchronization status.
- 2 View connection status.
- 3 Tap to connect and synchronize.
- 4 Tap to synchronize via Bluetooth or change synchronization settings.

Synchronizing using Bluetooth

Without using the USB cable to connect the two devices, you can still synchronize using Bluetooth. The greatest advantage is that you don't have to plug in and detach from the USB cable so often. This is especially useful for managing several Pocket PCs. For details on Bluetooth devices, refer to "Using Bluetooth" section.

7 Connections /

Connecting to the Internet

This section teaches you how to use GPRS wireless network connection. GPRS wireless networking is a convenient function for working at home or while traveling. You can use the Pocket PC to browse websites and read or send E-mails, SMS or MSN messages.

Make sure that your telecom company provides this service and apply for a SIM with GPRS function. If you already have a SIM card, all you need to do is apply for the GPRS function from your service provider. Current SIM cards can support GPRS networking functions.

Connection Wizard

Generally, you will only need to install the SIM card to your Pocket PC to simultaneously use the mobile phone functions. The system will automatically add the connection items for this SIM card. To verify: Tap  **Settings**, the **Connections** tab, **Connections**, and then “Manage existing connections,” the list will show the newly added network name.

If the system is unable to successfully add the connection to your SIM card, it is possible to use **Connection Wizard**.

Tap , **Settings**, the **Connections** tab, and then **Connection Wizard**.



1. Select the country name from the list.
2. Select the carrier name from the list.
3. According to actual requirements, select the carrier name, and then tap **Add** Button or **Edit** Button. Or use the **New** Button to add the new network connection.
4. **Search** Button: Detect the currently available telecommunication service. If it is found, use the **Add** Button to add the highlighted selection. If it is not found, the “New network” screen will be shown; please manually setup the network.
5. **Recovery** Button: Restore to the original setup value.
6. Tap , **Settings**, the **Connections** tab, **Connections**, and then “Manage existing connections,” the list will show the newly added network name.

Setting the GPRS Connection

Tap , **Settings**, the **Connections** tab, **Connections**, and then the **Tasks** tab.



1. As shown in the screen on the left tap “Add a new modem connection.”



2. Enter the “Make New Connection” screen as shown in the screen on the left.

- ❶ Input a new connection name for convenience in making connections in the future.
- ❷ Select “Cellular Line (GPRS).”
- ❸ Lastly tap **Next**.

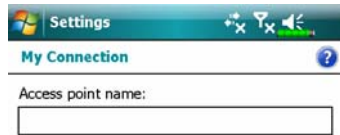









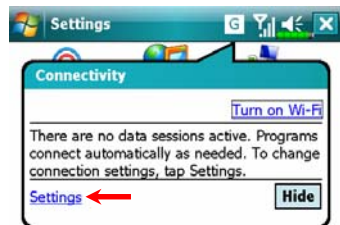
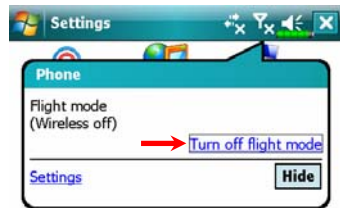

3. Input the Access Point Name provided by your telecom company and tap **Next**.

4. Input your personal information such as account number, and tap **Finish**.





Starting GPRS Connection

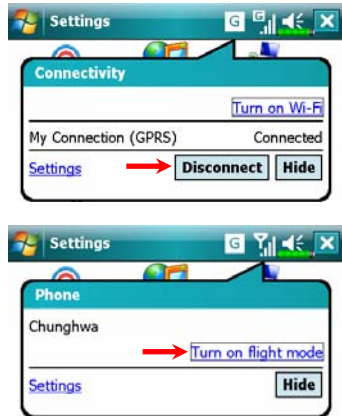

1. Tap the  or  icon at the top of the screen and when a message window appears tap “Turn off flight mode” and input your PIN to turn on the Phone. The  icon will change to  while the  icon changes to .
2. Tap , then tap **Settings** to link to **Connections**. You are ready to connect GPRS.
3. Select “Manage existing connections” in **Connections**. Tap and hold on the newly created connection name, and then select **Connect** to finish GPRS connection.
4. Input your account information in the Logon Network screen and tap to login to the network.
5. After the connection is established, the  icon will change to .
6. Now you can use the appropriate program to access the Internet, receive or send E-mails, etc.

Disconnecting GPRS



1. Disconnect GPRS: Tap  and the message window appears. Tap **Disconnect**.
2. Turn off Phone: Tap  and the message window appears. Tap “Turn on flight mode.”

Using Bluetooth

Bluetooth is a short-distance wireless communication technology with an effective range under 10 meters (30 feet). When you enable Bluetooth function, the blue LED blinks once every 4 seconds.



Bluetooth Connection Wizard

Tap **Programs, Utilities**, and then **Bluetooth Manager**.



- 1 Tap on any one of the icons on the left side of the Wizard screen, the system will ask you if you would like to activate Bluetooth. After activation, the LED indicator on the upper left will flash blue.
- 2 Tap here and the system will search for all nearby Bluetooth headsets.
- 3 Tap to configure your Bluetooth device.
- 4 Tap to enter the Bluetooth device pairing screen.

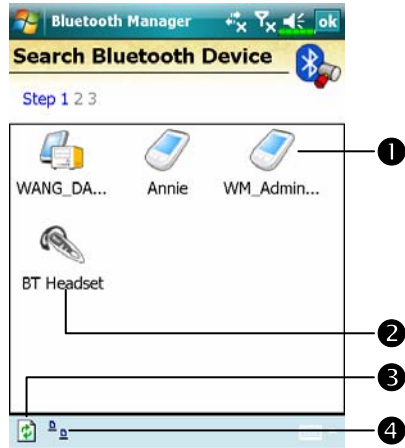

⌂ All nearby Bluetooth devices found by the system.

① Tap on any one of the shortcut icons and you will be able to follow the on-screen instructions to pair with that particular device. Devices that have already been paired with are shown with a .

② Tap on one of the icons which represent a Bluetooth headset, when a is shown, it means that you may use that particular Bluetooth headset.

③ Refresh Search Button: re-scan for all nearby Bluetooth devices.

④ Change viewing method.

⌂ Tap **Bluetooth Manager** Button in the Wizard Mode screen to enter this screen.

① The system will search once again and add to the number of the devices that you may pair with.

② Return to Bluetooth Wizard.

③ Tap to configure your Bluetooth device.

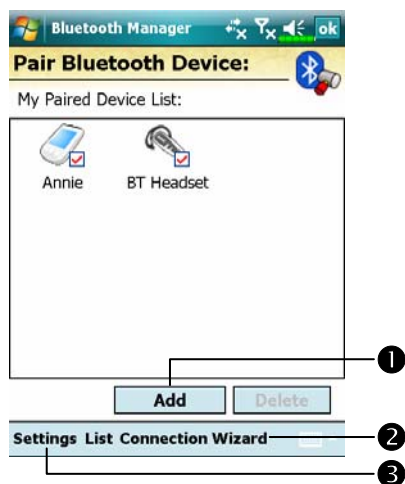

Bluetooth Connection Setting

Tap **Settings** Button in the Bluetooth Wizard screen to display the Bluetooth Settings screen.

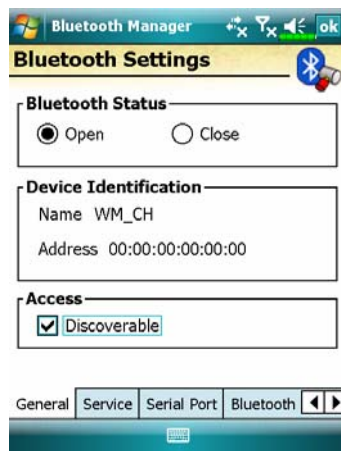

Tap the **General** tab

1. Bluetooth Status

1 Tap **Open** to enable Bluetooth function.

2 Tap **Close** to disable Bluetooth function.

Make sure that you disable Bluetooth function when you need to save power or if you are in locations such as an airplane or hospital that ban the use of wireless devices.

2. Device Identify

1 **Name:** Other devices supporting Bluetooth can identify your Pocket PC by this name.

2 **Address:** This is the unique address of your Pocket PC.

3. Access

1 Check “Discoverable”: Within an effective range of 10 meters (30 feet), all devices supporting Bluetooth can detect your Pocket PC and data transmission is performed with confirmation from the other party.

2 Uncheck “Discoverable”: Your Pocket PC can transmit data to other devices but other devices cannot detect your Pocket PC.

Service



Tap the **Service** tab

Provide the settings about services of serial port, file transport and exchange vCard.

Serial Port

If you have Bluetooth GPS software, use the product as instructed and refer to the accompanied documentation and this section to register your Pocket PC as an effective serial port or search for other serial ports.



Tap the **Serial Port** tab

Register new serial port

1. Tap **Add** to enter the Settings screen.

▣ If you no longer need to use a registered serial port, tap this serial port under the “Name” column to highlight and then tap **Delete** to delete it.

2. The figure on the left shows the settings screen for registering a new serial port.



Bluetooth Headset



Tap the **Bluetooth Headset** tab

1. Select a headset from the paired list.
2. Check "Use Headset."

FTP Sharing



Tap the **FTP** tab

Specify one of the folders on your Pocket PC as a shared directory.

CSD Type

Tap , **Settings**, the **Connections** tab, and then **CSD Type**.

You must first apply for Circuit-Switched Data (CSD) service from your telecom company before you can use this function. In short, this function is similar to the modem dial-up in a personal computer. By simulating the Pocket PC as a modem and connecting through the built-in GSM device, you can use the Pocket PC to access the web.

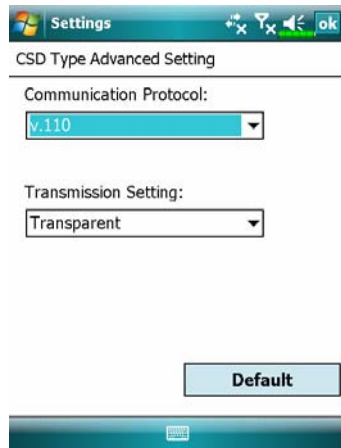

This figure is for reference only.

The parameters shown in the screen will be based on the settings provided by your telecom company. The charge rate is regulated by your telecom company.

Connecting with a Personal Computer

For more information, refer to “Synchronization” section.

Wireless LAN Transmission

Tap the **Wireless Manager** icon  on the lower right corner of the Today screen. For more information, refer to “Using Wireless LAN” section.

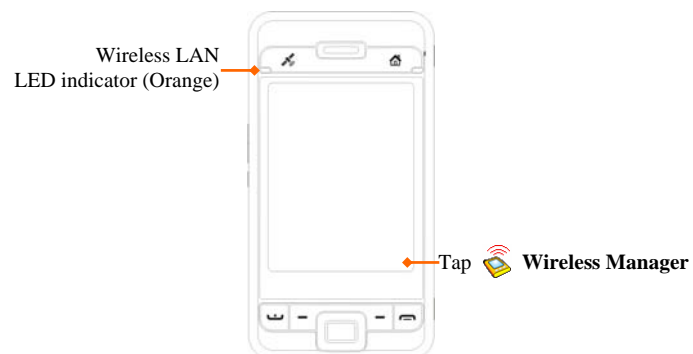



8 Using Wireless LAN /

Connecting to Wireless LAN

This section teaches you how to use the Pocket PC's built-in wireless LAN function to connect to the Internet. It is convenient for you to browse websites and send/receive E-mails through wireless networks at certain locations where wireless networking services are provided.

When you purchase credits for connecting to the Internet through a wireless LAN, you will be given the following information: an IP address, DNS name server address, Proxy server, port, and network key, etc. You need this information to setup and activate your connection. In some cases, you may need additional information to use a company's wireless connection, please confirm with the network administrator in your company.

If this is your first time using the wireless LAN function, firstly you should refer to the following "Configure Your Wireless Network" section for instructions for the necessary configuration settings. After you have completed the one-time configuration process, you only need to select the  icon in the **Wireless Manager** main menu for subsequent connections.

Tap the  icon on the bottom right of the Today screen.

Tap , **Programs** and then **Wireless Manager**.



1 This icon will show up on your screen whenever your Pocket PC has detected a usable wireless network and has connected to that network, indicating that your Pocket PC has successfully connected to the network hotspot (Access Point). At this point, the indicator on the upper left of your Pocket PC will flash orange.

2 Tap to enter the setup screen.

3 Tap to connect or disconnect to your wireless network, a  means that this function has been disabled.

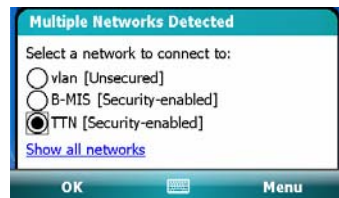

When the screen shown on the left appears, please choose a wireless network that you can use, and then tap **OK** Button. Then, select **Work**, and tap **Connect** Button.

The first time you use the wireless LAN function, your system will ask you to set the above mentioned settings, after that, your system will continually use the settings from your most recent successful connection.



Configure Your Wireless Network

WLAN Setup Scenarios

Location	Select Networks	Proxy Connection	Network key or Access Point
Home	 Settings , the Connections tab, Connections , the Advanced tab, Select Networks Button, and then select My Work Network from “Programs that automatically connect to the Internet should connect using:” menu	<ol style="list-style-type: none"> 1. Close Proxy connection 2. Not required to set Proxy 	<ol style="list-style-type: none"> 1. Authentication: Select Open 2. Data Encryption: Select WEP to enable the entry bar regarding Network key
Office	Refer to the above and set as My Work Network	 Settings , the Connections tab, Connections , the Tasks tab, select “Edit my proxy server,” and then check the Internet items to enable the entry bar about Proxy	Refer to the above and set the items for Network key
Café or restaurant	Refer to the above and set as My Work Network	<ol style="list-style-type: none"> 1. Close Proxy connection 2. Not required to set Proxy 	WLAN select different Access Point



Configure Your Wireless Network

(Reference for a normal network setup)

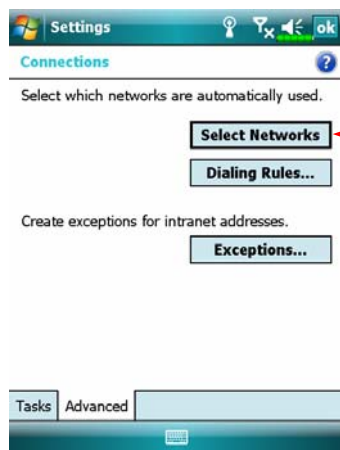
You will need a correct IP address, DNS name server address, Proxy server, and connection port number to setup your connection. If you have purchased a wireless Internet service account, then the service desk at the location where you will be connecting will provide you with this information, or, you should obtain this information from the network administrator of your company.



When your Pocket PC is unable to automatically detect or connect to a usable wireless network, please try to configure the network manually. Please refer to this section's settings instructions.

1. Select the  icon in the **Wireless Manager** main menu, a  icon will display on the navigation bar.
2. Then tap , **Settings**, the **Connections** tab, **Connections**, and then the **Advanced** tab, the screen displays shown on the left.
3. Select the **Select Networks** Button.

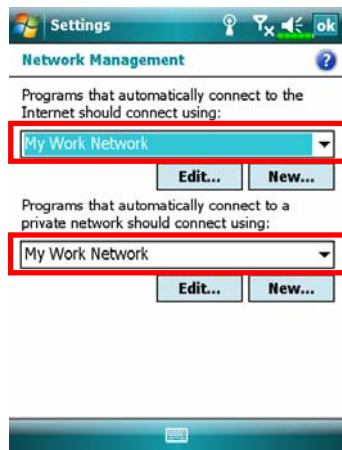

4. As shown on the left, make sure that **My Work Network** is selected for both items, and finally tap **ok** to save and exit.

■ **My Work Network** is the WLAN connection method. As this option is from a choice of two, the next time you need to use the GPRS connection, you will have to refer to the above listed steps, select **My ISP** for the first item.

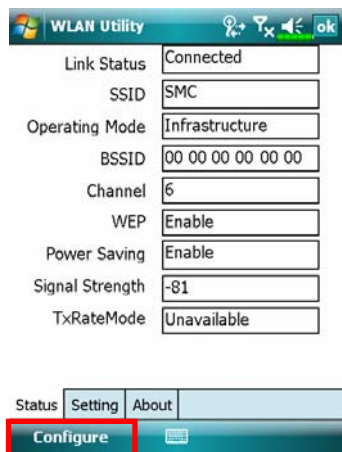

5. In the **Wireless Manager** main menu, select  to enter the **WLAN Utility** screen.

6. Then select the **Configure** Button to enter the WLAN setup screen.





7. Select name of a currently available network to enter the WLAN authorization setup screen.

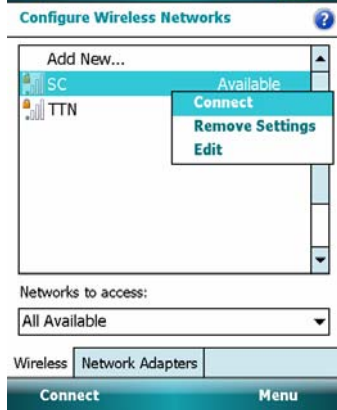

8. Set accordingly to the rules and information provided by the hotspot location.

- ❶ **Authentication:** Select Open
- ❷ **Data Encryption:** Select WEP to enable the entry bar about Network key
- ❸ **Network key**
- ❹ **Network index**



9. Tap and hold on the name of the network connection that you can currently use, then select **Connect**. When the  icon appears on the top of the screen, your wireless network has been successfully connected.

Configure Your Wireless Network

(Reference for Proxy setup)

To successfully configure your network, you will need the following information: a correct IP address, DNS name server address, Proxy server, and connection port number, etc. Please obtain the above listed information from your company's network administrator. If your company's networking environment doesn't need Proxy server settings, please close the proxy connection.

Tap , **Settings**, the **Connections** tab, **Connections**, and then the **Tasks** tab.



When your Pocket PC fails to automatically detect or connect to a usable wireless network, please try using the manual method to configure your network settings. Please refer to the settings information in this section.

1. Select "Setup my proxy server" or "Edit my proxy server," as shown on the left.



2. In the **Proxy Settings** tab screen, make sure that the following items have been checked:

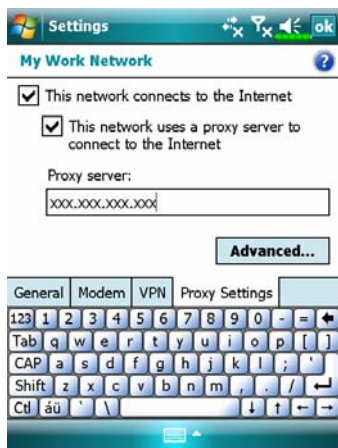

- 1 This network connects to the Internet
- 2 This network uses a proxy server to connect to the Internet

☒ The above is applicable to an office environment that requires a Proxy setup.

For others that close the proxy connection, please do not check the box named “This network connects to the Internet” and skip the following procedures.

3. Enter the name into the “Proxy server” field.

4. Select the **Advanced** button and enter the advanced settings screen.



5. You can modify the settings by tapping the HTTP type.



6. Enter the number into the “Port” field. Finally, tap **ok** to save and exit.

9 Sending and Receiving Messages

Tap  and then **Messaging**.

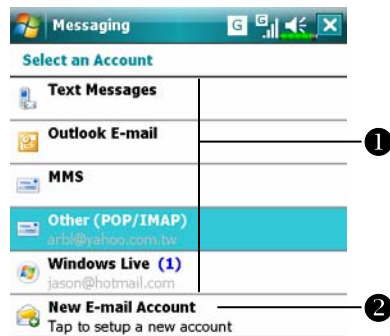

- 1 Tap to select an account.
- 2 Tap to setup a new E-mail account.
- 3 Tap to select the highlighted account above.
- 4 Change the account settings. Or delete a message.



Functions of the **Messaging** screen:

- 1 Select the service and folder you want to display.
- 2 Select the sort order for messages.
- 3 Tap to open a message.
- 4 Tap and hold to display a pop-up menu of actions.
- 5 Provides the relevant menu. For example, select **Go To** to switch to another account. Or select **New** to compose a message.
- 6 Tap to delete a message.

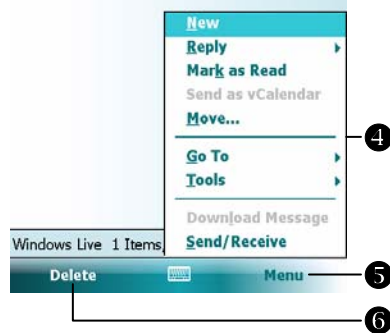

E-mails and SMS Messages

Refer to “Connecting to the Internet” section to learn how to connect the Pocket PC to the Internet and start using **Messaging** to send and receive E-mails and SMS messages.

This section explains the basic preparations and processing principles. If you have any questions, refer to online help about Pocket PC or synchronization.

Use **Messaging** to send and receive E-mails messages in either of these ways:

1. Send and receive e-mail messages by connecting directly to an e-mail server through an Internet service provider (ISP) or a network.
2. Synchronize e-mail messages with Microsoft Exchange or Microsoft Outlook on your desktop computer.

■ Inbox synchronization does not support synchronization with Microsoft Outlook Express.

Reference for using E-mail:

1. Refer to “E-mail Server Setup” section.
2. Refer to “Using E-mails and SMS”.

Reference for using SMS:

1. Refer to “Using E-mails and SMS” section.
2. To send and receive SMS only, you only need to turn on the Phone (antenna icon on the Navigation Bar is ). It is not necessary to connect GPRS to the network nor is it necessary to establish a new E-mail account and connection in **Messaging**.

Synchronizing E-mail Messages

If you want to synchronize e-mails with company or home usage, please refer to this section. E-mail messages can be synchronized as part of the general synchronization process. You will need to enable Inbox synchronization in synchronization tools. For information on enabling Inbox synchronization, see Help on the desktop computer.

During synchronization:

1. Refer to “Connecting to the Internet” section. Select the partnership you want to establish under “Set Up a Partnership” and you can start to synchronize data. If you choose not to synchronize data, you can manually copy or move E-mails between the Pocket PC and a personal computer.
2. E-mail messages in the “Outbox” folder on your Pocket PC are transferred to Exchange or Outlook, and then sent from those programs.
3. Exchange or Outlook E-mail is supported.
4. Mails in the Pocket PC Inbox folder will be transmitted to the personal computer and then sent out via Microsoft Outlook or Microsoft Exchange.
5. If you delete mail in the Pocket PC, this mail will also be deleted from the personal computer the next time the two devices perform synchronization.
6. SMS messages are not synchronized.

Connecting Directly to the Mail Server

For single-machine use, not combining office and home E-mails, please refer to “E-mail Server Setup” section.

You will receive messages directly from the mail server. This is irrelevant to personal computer use. You can work online or offline. When working online, you read and respond to messages while connected to the e-mail server. Messages are sent as soon as you tap **Send**, which saves space on your Pocket PC.

When working offline, once you’ve downloaded new message headers or partial messages, you can disconnect from the e-mail server and then decide which messages to download completely. The next time you connect, Inbox downloads the complete messages you’ve marked for retrieval and sends the messages you’ve composed.

Based on your preference, you can program the Pocket PC to receive mail for the last few days, receive subjects only or the entire mail, or just receive mail with file attachments smaller than a specified size. If you want to receive more or less mail, tap **Menu, Tools** and then **Options** to adjust the E-mail account settings according to your needs.

E-mail Server Setup

Refer to this section if you are preparing for single-machine use and not combining office and home E-mails. If you already have an E-mail account from your ISP or company network, you can use **Messaging** to send and receive mails and messages. To establish a new **Messaging** E-mail server on your Pocket PC, refer to the following sections.

1. Obtain the following information from your ISP or company's network administrator for convenience in setting up the E-mail service.
 - ❶ E-mail address, account name and password
 - ❷ POP3 or IMAP4 server name for internal mail
 - ❸ SMTP server name for sending mail

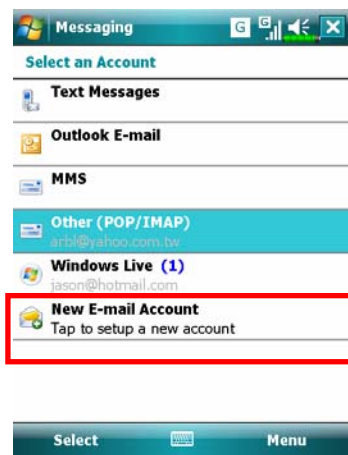

2. Setup a new E-mail account:
Tap , **Messaging**, and then select **New E-mail account**.



Is the source for your e-mail a corporate Exchange server or some other e-mail provider?

Your e-mail source:

Other

Typically, your Internet Service Provider (ISP), or other e-mail provider (POP/IMAP).



E-mail address

Enter e-mail address:

Try to get e-mail server settings from the Internet.

[Privacy Statement](#)



3. Select “Other” for the e-mail source.
4. Select “Other (POP/IMAP)” for the e-mail provider.

5. Follow the instructions on the screens to setup the E-mail account.

6. Refer to “Connecting to the Internet” section or “Using Wireless LAN” section to connect the Pocket PC to the Internet and you can start sending and receiving E-mails and SMS messages.

7. Connecting to the E-mail server:

❶ Tap **Messaging, Menu, Go To**, and then check “Other (POP/IMAP)”.

❷ Tap **Menu** and then **Send/Receive**.

❸ Tap **Menu, Tools** and then **Options** to change the E-mail account.

Using E-mails and SMS

Below is a brief description of the **Messaging** screen functions:

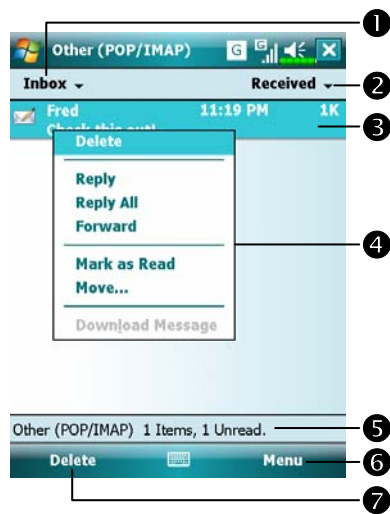

- ❶ Select the service and folder you want to display.
- ❷ Select the sort order for messages.
- ❸ Tap to open a message.
- ❹ Tap and hold to display a pop-up menu of actions.
- ❺ Status bar
- ❻ Tap to change the account settings.
- ❼ Tap to delete a message.

Brief description on writing, sending, reading and replying (to) mail:

1. Send and Receive Mail: Tap **Menu** and then **New** to compose a message and then tap **Send** to send it.

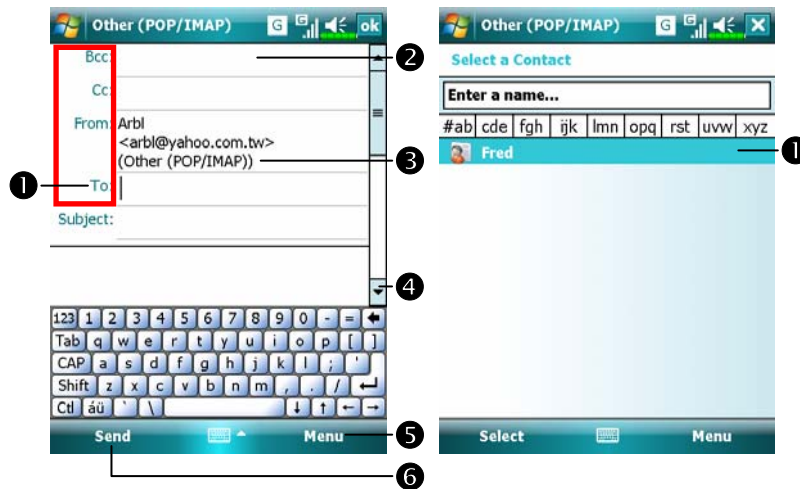

- 1 Tap **To**, **Cc** or **Bcc** to open the **Contacts** screen. As long as you have set up **Contacts** beforehand, you can just tap to select.
- 2 Tap the data area to input the E-mail address, mobile phone number and subject directly. If there is more than one contact, use a semi-colon (;) to separate the addressees.
- 3 **POP/IMAP** means to send E-mail, and **Text Messages** means to send an SMS message. Note that the same message cannot be sent as E-mail and SMS message at the same time.
- 4 Use the scroll bar to view the header.
- 5 **Menu** Button: Provides frequently-used functions for writing mail such as request return receipt, attach files to E-mail, select canned messages, edit canned messages or cancel mail.
- 6 **Send** Button: Send your messages.

2. Read and Reply: Receive new mails by tapping **Menu** and then **Send/Receive**. Switch to the “Inbox” folder and tap to open. The following figure shows the open mail screen.



➡ Besides reading the messages, provide frequently-used functions for replying to or forwarding.

3. Change preference settings.

- ❶ Set the Inbox Synchronization option in synchronization tools.
- ❷ Tap **Messaging**, **Menu**, **Tools**, **Options**, and then the **Accounts**, **Message ...** tabs on the Pocket PC to set the appropriate options.

Direct Push Technology Alert

The Direct Push Technology alert function will enable you as a corporate user to never miss another e-mail, using the Pocket PC for the best business service. Through the synchronization feature, your Pocket PC can instantly and automatically receive important e-mails from Microsoft Exchange Server.

Direct Push Technology Alert Settings

The following description will explain how to setup the synchronization program on the Pocket PC end, and to directly synchronize the Pocket PC with Exchange Server. This way, your device under GPRS or wireless network connections will be able to receive in-coming e-mail alerts, and be able to instantly read the messages.

A reminder that if you selected the connection method to be wireless network, for power saving purposes when the Pocket PC enters sleep mode the connection will be broken. During this time you will not be able to receive instant e-mail. However, you will only need to press the “Power Button” to automatically complete the connection to the wireless network.

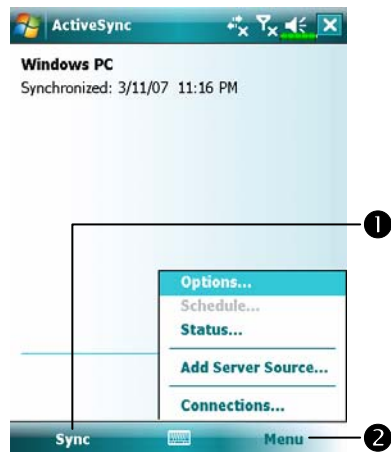

1. Tap , **Programs, ActiveSync, Menu**, and then **Configure Sever**.

▣ If the Exchange Server synchronization has not been setup before, please select **Add Server Source**.

- 1 Tap to connect and synchronize.
- 2 Tap to modify the synchronization settings.



2. Obtain the server address, user name, network etc. from the company network administrator to successfully setup the server data.

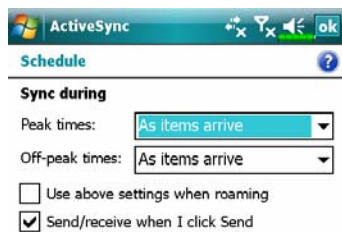

3. Tap **Menu** and then **Schedule**. The **Peak times** and **Off-peak times** provide a **As items arrive** option, this is the direct push technology alert function.



Windows Live™ Messenger

To switch to Windows Live™ Messenger, tap , **Programs**, and then tap **Windows Live™ Messenger**. Windows Live™ Messenger on your Pocket PC is an instant messaging program that lets you:

- See who is online.
- Send and receive instant messages.
- Have instant message conversations with groups of contacts.

For more information on using Windows Live™ Messenger, tap  and then **Help**.

To use Windows Live™ Messenger, you must have a Microsoft Passport™ account or a Microsoft Exchange e-mail account. You must have a Passport to use Windows Live™ Messenger Service. If you have a Hotmail® or MSN account, you already have a Passport. Once you have obtained either a Microsoft Passport or a Microsoft Exchange account, you are ready to set up your account.

- Sign up for a Microsoft Passport account at <http://www.passport.com>. Get a free Microsoft Hotmail e-mail address at <http://www.hotmail.com>.

Setting Up

☰ The first time you use: Tap , **Programs**, and then **Windows Live™ Messenger**.

☰ On the Today screen, tap **Messenger** to display the **Windows Live™ Messenger** sign-in screen.

Before you can connect, you must enter Passport or Exchange account information.

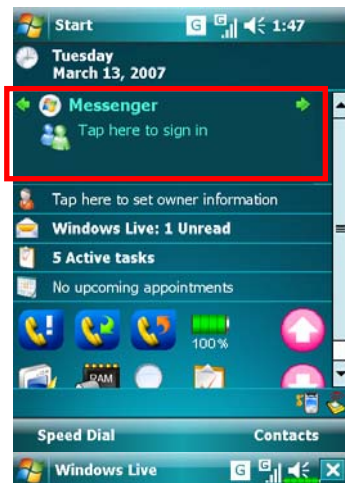

1. Tap **Messenger** on the Today screen.

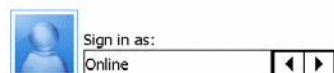

2. Tap **Sign in**.

Working with Contacts

If you already use Windows Live™ Messenger on your desktop computer, your contacts will show up on your Pocket PC without being added again.

The Windows Live™ Messenger window shows all of your messenger contacts at a glance, divided into Online and Offline categories, or sorted by groups. From this view, while connected, you can chat, send an e-mail, block the contact from chatting with you, or delete contacts from your list using the pop-up menu.

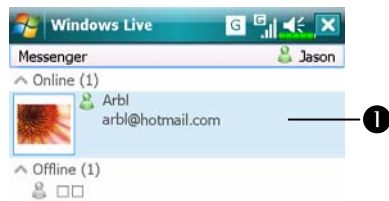

① Tap a contact to start a chat.

② Provides the relevant menu.

For example, select **Add new contact** to create a new MSN contact. Or select **Sign out** to quit from Windows Live™ Messenger.



▣ To see others online without being seen, tap **Menu, Change status**, and then select **Appear Offline**.

If you block a contact, you will appear offline but will remain on the blocked contact's list. To unblock a contact, tap **Menu, Contact options**, and then **Unblock contact**.

Chatting with Contacts

Tap a contact name to open a chat window.



- 1 View full chat.
- 2 Enter your message in the text entry area, and tap **Send**.
- 3 Return to the contacts list, and select a contact to chat with.
- 4 The contact you are chatting with.
- 5 Provides the relevant menu.

For example, to invite another contact to a multi-user chat, select **Options** and then **Add participant**, and tap the contact you want to invite.

MMS Message

Tap , **Messaging**, and then **MMS**.

Tap , **Programs, Phone**, and then **MMS Message**.

The **MMS Message** mailbox is very similar to ordinary E-mail mailbox function. “Inbox” saves the MMS that you received while “Outbox” saves the MMS that you are going to send. “Sent” saves a backup copy of the MMS sent successfully. “Drafts” saves incompletely edited MMS messages.

Create and Edit MMS

How to compose a new MMS message:

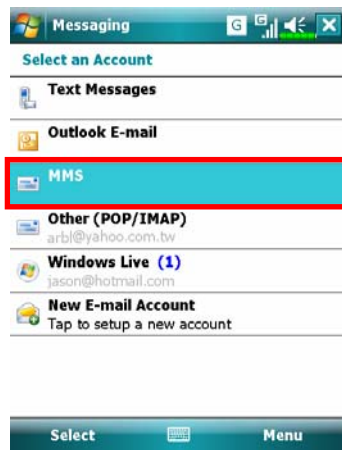

1. Tap , **Messaging**, and then **MMS**.

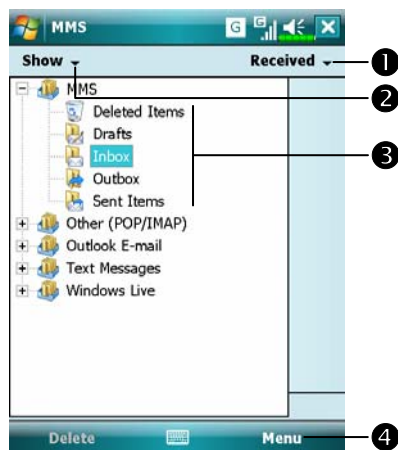

2. Tap **Menu** and then **New** to add a new MMS.

- ① Tap to change the MMS sort method.
- ② Select the folder types you want to display in the list.
- ③ Tap to manage your MMS mailbox.
- ④ Provides the relevant menu.

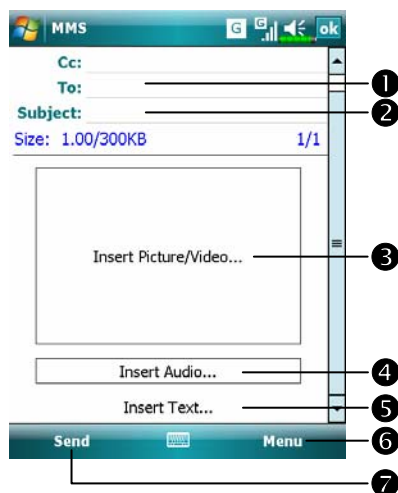

3. The MMS template displays. You can edit freely.

- ① Tap **To** button to select a phone number or E-mail address from your **Contacts**. You can tap the entry area to input the phone number or E-mail address also.
- ② Tap to input the subject.
- ③ Tap the specified area to insert the picture/video file.
- ④ Tap the specified area to select the audio file.
- ⑤ Tap the specified area to edit text.
- ⑥ Provides the relevant menu.
- ⑦ Tap **Send** button to send the MMS messages.

Birthday Reminder

Tap , **Programs, Utilities**, and then **Birthday Reminder**.

Combines **Contacts** and this application, you may store birthdays and anniversary dates in the **Contacts** card first. When the day comes, a message will remind you to send a SMS, MMS, make a phone call or send an email to him/her and stay a warm connection forever.



1. Using the main screen

- 1 A remark icon of a birthday or anniversary, tap the icon to show the details you stored.
- 2 Select the desired monthly calendar you want to view.
- 3 Tap here to set the corresponding features.
- 4 Tap here to add a new contact.

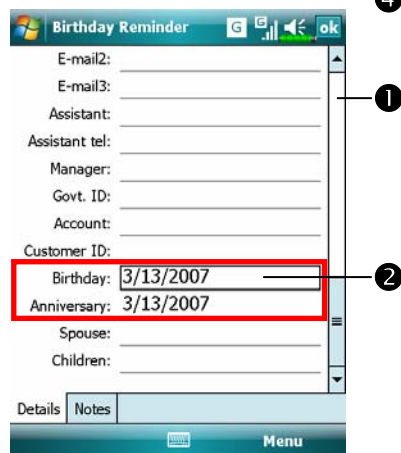

2. For adding a new contact, you may tap **New** on the main screen.

- 1 Use the scroll bar to scroll the pages.
- 2 Find the **Birthday** or **Anniversary** field and enter the data.



3. For setting the corresponding features, you may tap **Settings** on the main screen.

① Tap the check box to display a popup message for reminding.

② The options of reminding methods.

Remind you once: at 8:00 A.M.

Remind you two times: at 8:00 A.M. and noon.

Remind you three times: at 8:00 A.M., noon and 6:00 P.M.

③ Select the desired background image of main screen.

4. When the reminding date you set comes, the Pocket PC phone will popup a message on the screen to remind you.

5. Tap the  icon on the top of screen and tap **Preview** to enter the birthday or anniversary reminder settings screen.



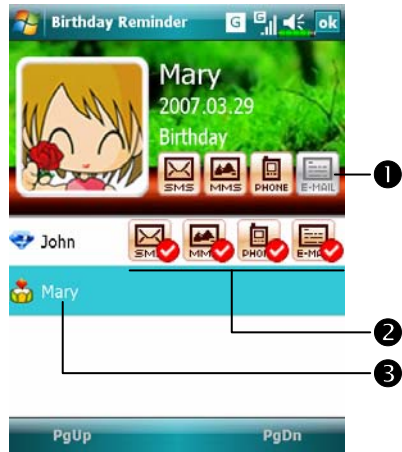

6. Moreover, you may tap the 🎁, 🌹, or 📧 icons on the calendar of main screen.

- ① You may send a SMS, MMS, make a phone call or send an email to him/her after selected corresponding icons.
- ② Show you that you ever sent greeting messages to this contact.
- ③ Select one contact to be the message recipient.

Namecard Manager

Tap , **Programs, Utilities**, and then **Namecard Manager**.

Provides full name cards management for scanning paper name cards into a digital format. The contacts database from Pocket PC can also be integrated into a unified contacts book.

Digitize New Name Cards





1. Tap **Recognize**.

2. **Tip:** Before taking a picture, please take the following pointers to improve recognition quality.

- ❶ If the original name card is a landscape design, it is recommended that you rotate the Pocket PC before taking the picture.
- ❷ Keep the Pocket PC's camera lens at a distance of 10~12cm.
- ❸ Fill the four corners of the screen marked by red indicators with the name card.



3. **Take the picture:** Prepare a name card and adjust the position. Press the shutter  to the side of the Pocket PC to take the shot.

☑ Directly select  on the screen to perform the same function.

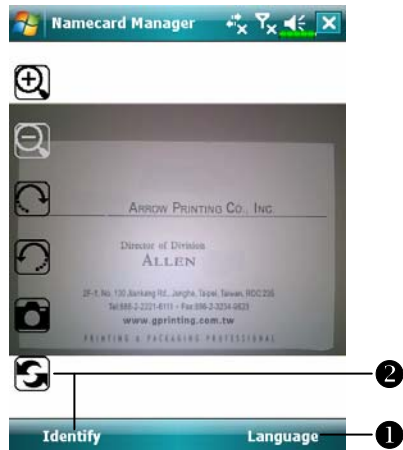

4. **Name card recognition**





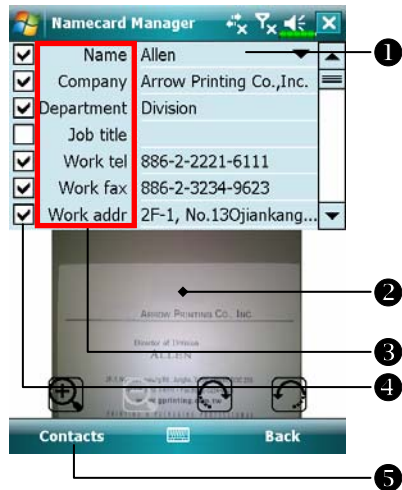





① Select **Language** to choose the appropriate language for this name card.

② Select  or **Identify** to recognize the contents on the name card.



5. Modify the name card's contents and confirm

- ① Select the contents field to make modifications.
- ② When selecting the contents field, the name card source will be shown for verification. Double tap on the name card area to zoom to the max viewing.
- ③ Select the field name to modify and adjust the error recognitions.
- ④ Choose whether to keep this data entry.
- ⑤ Add this name card to the contacts database on the Pocket PC. Go back to **Contacts** to view the new entry.

Icon	Meaning
 	Enable or disable the flashlight.
 	Select storage path
	Take a picture. Identical to the  shutter at side of a Pocket PC. If the result is not satisfactory, retake the picture.
 	Increase or decrease zoom.
 	Rotate left or right.
	Identify name card.

Name Cards Management



1. Tap **Manage**.

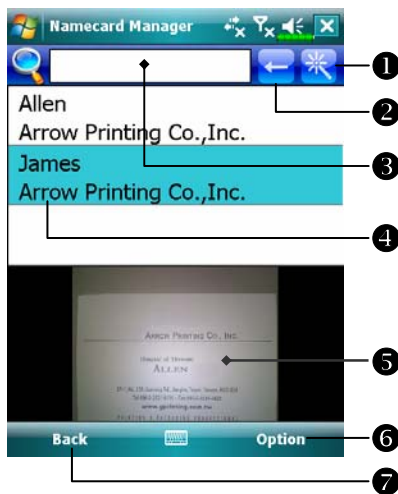

2. Main screen for name card

management: Only recognized name cards will be shown here.

① Enter the quick search page. Tap a letter and the results for name cards created in **Namecard Manager** will be shown.

② Delete the entered text to the left.

③ Search criteria for name card. All matching name cards for “Name, Work, or Tel” will be shown on the screen. To search for all name cards, please leave the field blank.

④ Name card index display area, select an entry to expand its contents.

⑤ Display area for the original name card.

⑥ Provides the relevant menu.

New: Create a new digital name card.

Import: Supported format includes BMP, JPG, and PNG. An existing name card image file can be imported and then processed.

Edit: Modify the name card information.

Delete: Delete the selected name card.

⑦ Return to the previous page.

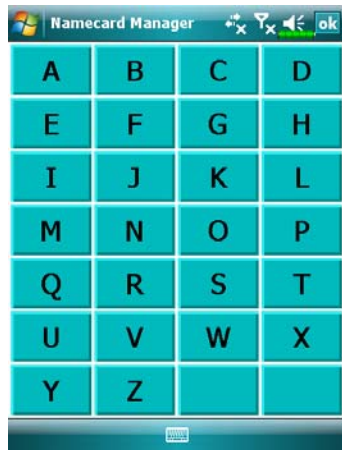

3. Quick search screen



After selecting a letter, the name cards created in **Namecard**

Manager will be shown. The matching name or company entries will be shown on the name cards management list.

10 Multimedia /

Using Camera

Tap  Tap , **Programs, Multimedia**, and then **Camera**.

1. To take photos of scenery or of other people, turn the Pocket PC so the screen is facing you and when you are satisfied with the composition, press the  button on the side of the Pocket PC.
2. To take a picture of yourself, turn the Pocket PC around so that the preview mirror is facing you.
3. Tap  and then **Messaging** to send the picture as an attachment in an E-mail.

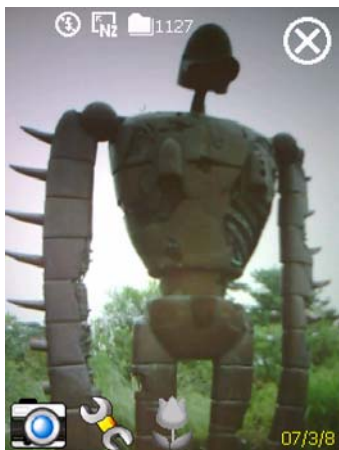

① Shutter ② Lens ③ Preview mirror ④ Adjust focus









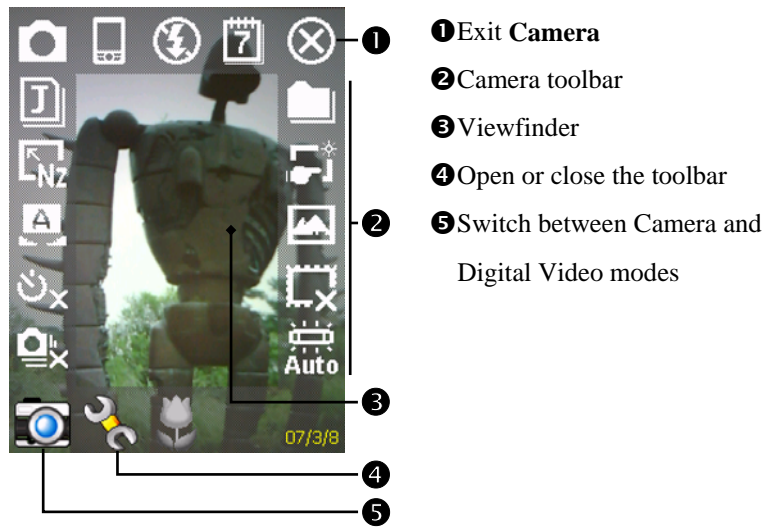





Shooting Tips

To take a self-portrait, it is best to face into the light. For best photo results, avoid backlit or dark areas.



Camera Mode

You can use **Camera** to shoot pictures and videos. This section describes the **Camera** tools.



Icon	Meaning
	Photo mode: Normal, Timer, Continuous shutter, Portrait
	Activate "Timer" to select the fixed time for shooting a picture
	Activate "Continuous shutter" to select the number of pictures to be taken
	Choose landscape or portrait
	Enable or disable the flash function
	Display or hide the date
	Select file format
	Select resolution. The higher the resolution, the larger the picture files.
	Select scene
	Select storage path
	Enable or disable Wizard
	Select special effect
	Select picture frame
	Select Frequency
	Enable or disable auto-macro focus





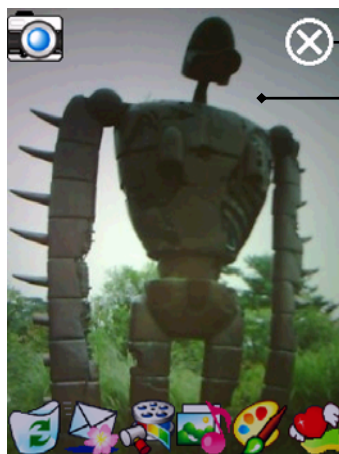

Camera Mode Using Wizard

Tap  or  to select **Wizard**. After you press the shutter button on the side of the Pocket PC, the Wizard will guide you through how to link to other programs conveniently. This section explains the Wizard tools.



- ❶ Exit **Camera**
- ❷ Photo-viewing area, retains the last photo just taken
- ❸ Wizard toolbar

☑ If “Continuous Shutter” is selected, it will directly open or use the last picture just taken when linking to other programs.

Icon	Meaning
	Return to Camera to continue taking pictures
	Delete current picture
	Connect to Messaging
	Connect to Multimedia Manager
	Connect to MMS Message
	Connect to Image Maker
	Connect to Image Wizard

Managing Pictures Shot by Continuous Shutter

Tap  to select “Continuous shutter” in the wizard mode. After you press the shutter button, you can preview all thumbnails just shot and delete the unnecessary one.

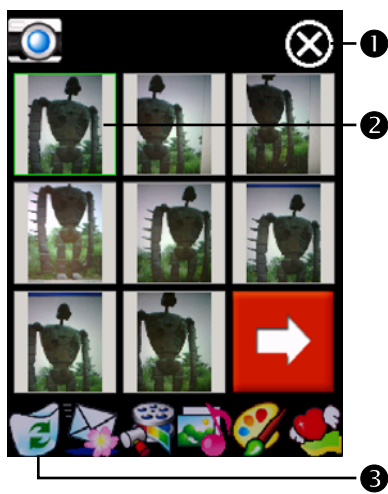

- ❶ Exit Camera
- ❷ Tap the thumbnail that you want to delete
- ❸ Tap  on the toolbar to delete the unnecessary picture

Digital Video Mode

Recording without entering the **Camera** screen: Directly press and hold the  Recorder Button for a few seconds and then release to start recording. To finish recording, press the Recorder Button to stop.

 Tap , **Programs, Multimedia**, and then **Camera, DV Mode**.

1. Since only horizontal (landscape) mode is supported, please rotate your Pocket PC 90 degrees when recording.
2. To shoot a video, turn the Pocket PC so the screen is facing you, press the  Recorder Button on the side of the Pocket PC to start recording. To finish recording, press the Recorder Button again to stop.
3. To shoot the footage of yourself, turn the Pocket PC around so that the preview mirror is facing you.

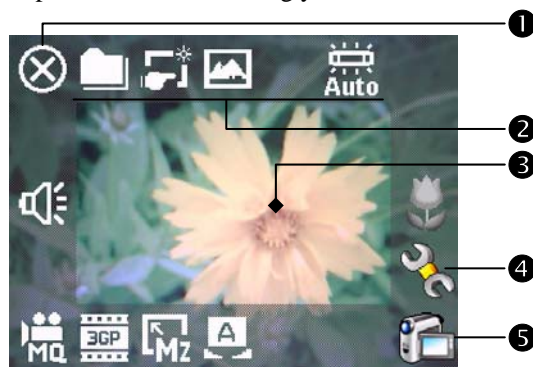

 This section explains the **Camera**'s digital video tools.

1 Exit **Camera**











2 Digital Video Mode toolbar

3 Viewfinder



4 Open or close the toolbar

5 Switch between Camera and Digital Video modes

 The recording format is 3GP, you can play back the video file on a personal computer.





Icon	Meaning
	Recording quality. The higher the resolution, the larger the file.
	Select file format
	Select resolution. The higher the resolution, the larger the file.
	Select scene
	Enable or disable sound recording
	Select storage path
	Enable or disable Wizard
	Select special effect
	Select Frequency
	Enable or disable auto-macro focus

Digital Video Mode Using Wizard

Tap  or  to select **Wizard**. After you finish recording, the Wizard will guide you through how to link to other programs conveniently. This section explains the Wizard tools.



- ❶ Exit Camera
- ❷ The photo viewing window stops at the first scene of the video you just recorded.
- ❸ Wizard toolbar

Icon	Meaning
	Return to Camera and continue shooting videos
	Delete current video
	Connect to Messaging
	Connect to Multimedia Manager
	Connect to Windows Media

Speed Shooting Using the Hardware Hotkeys

■ Capture Mode

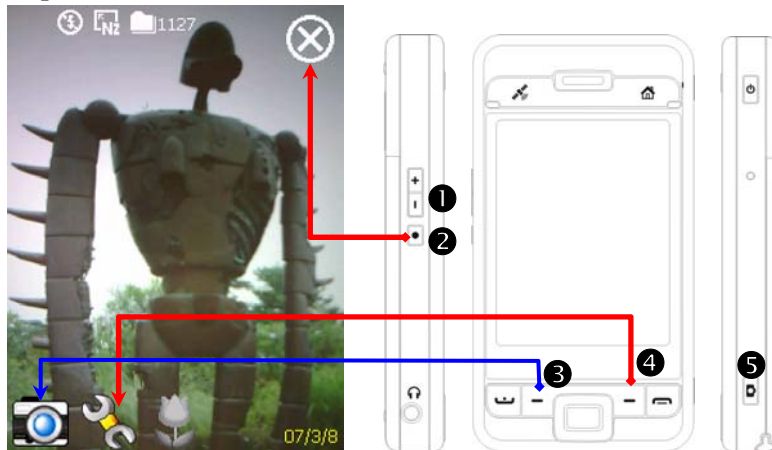

- ❶ Adjust Focus ❷ Exit Camera
- ❸ Switch between Camera and Video Recording modes
- ❹ Open or close the toolbar ❺ Camera Shutter/Video Recorder

■ Setting Mode/Wizard Mode

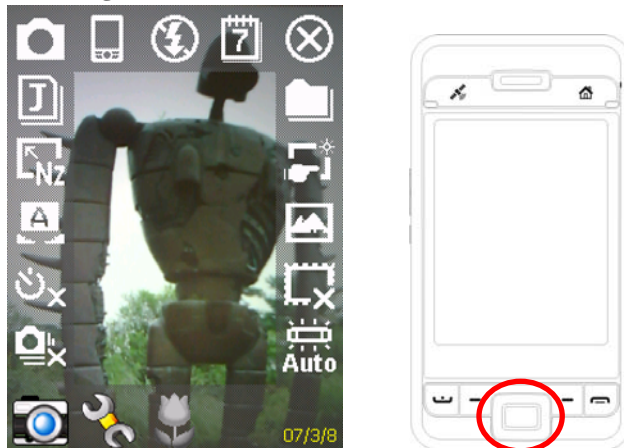

- ❶ Use the Navigation Button to navigate up, down, left and right to select from the icons on the screen.
- ❷ Press the middle button to execute selection.

Multimedia Manager

Tap , **Programs**, **Multimedia**, and then **Multimedia Manager**.

You can use **Multimedia Manager** to manage and view multimedia information such as pictures, music, videos, etc.

Preview Multimedia Information

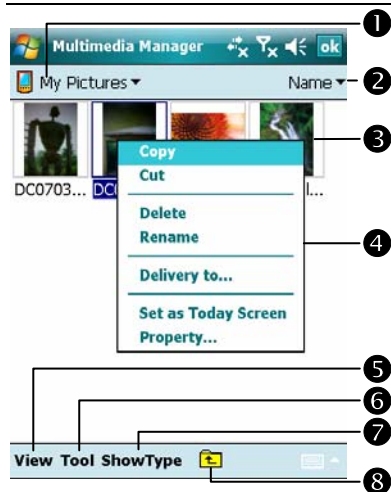

- 1 Select the folder you want to display.
- 2 Tap to change the order of the list.
- 3 Preview thumbnail. Set according to the multimedia information placed in the folder. If you are browsing pictures, tap a thumbnail to display the full picture. If you are browsing music or video, tap a thumbnail to play.

4 Tap and hold the thumbnail and when the pop-up menu appears, select the desired functions.

5 **View** Button: Select other types or auto-play pictures as a slideshow.

6 **Tools** Button: Create new folders, link to other usable programs and set the viewing method.

7 **Show Type** Button: Select to display as large or small picture and the number of pictures per row.

8 Tap to the upper directory.

Slide Show Function

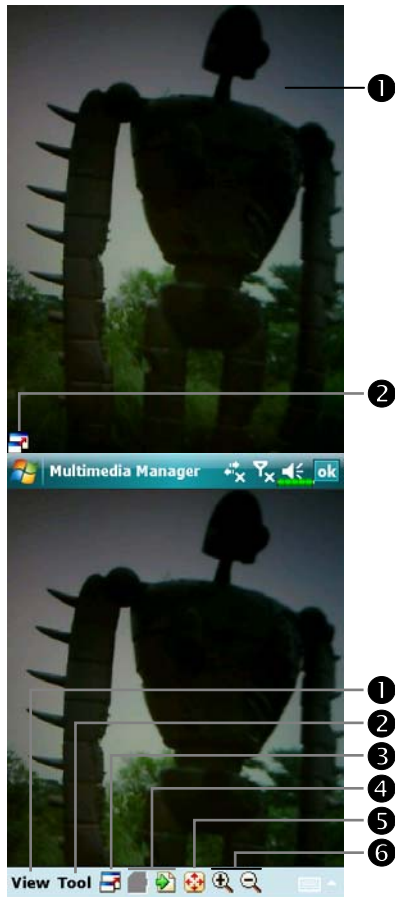

Tap **Multimedia Manager**, **View**, and then **SlideShow**.

1 Double tap anywhere on the screen to exit the slideshow.

2 Playing the last picture while not in the slide show looping mode, tap the screen and then tap the  icon to exit the slideshow.

Refer to the method described above to exit the slideshow and enter the screen shown on the left.

1 Select the picture scale, rotation and view picture properties.

2 Link to other available programs.

3 Full-screen view. To exit full-screen mode, tap the screen and then tap the  icon on the lower left corner of the screen.

4 View the previous or next picture.

5 Enlarge or shrink to the suitable screen size.

6 Zoom in or out.

Multimedia Manager Tools



Tap **Multimedia Manager, Tools**, and then **Setting**.

① **Slideshow** tab: As shown on the left, this is the settings of the slideshow mode.

② **Association** tab: Select the desired file type you want to open with **Multimedia Manager**.

③ **File Browse** tab: Set the browsing method.

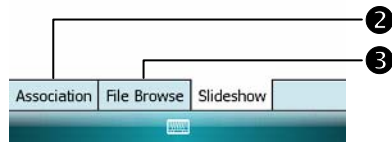

Tap **Multimedia Manager, Tools**, and then **Delivery**.

① Tap thumbnail. The in the upper left corner indicates that it is already selected.

② **Next**: Select the program to link to. For example, if you select “Image Maker,” you will go to **Image Maker**.



Image Maker

Tap , **Programs, Multimedia**, and then **Image Maker**.

Image Maker is used to create, edit and view pictures. Use it to view and edit the pictures you take. You can also use the relevant **Image Maker** commands and tools such as rotate, stretch, brightness, etc. to edit and process the graphics.

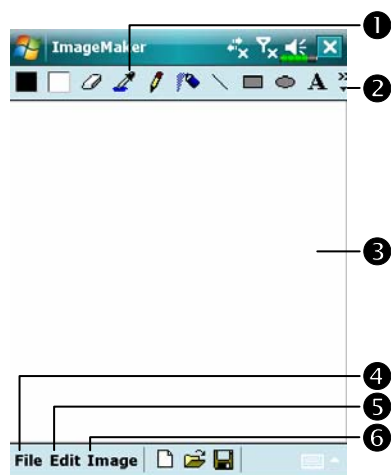

❶ Drawing tool box.

❷ Tap to utilize more drawing tools.

❸ Drawing or image editing area.

When the image file exceeds the viewing range of the editing area, tap the scroll button on the right or bottom of the screen.

❹ **File** Button: Provides file management function such as opening and saving files.

❺ **Edit** Button: Provides editing functions such as undo, copy and paste, etc.

❻ **Image** Button: Provides special effects for pictures.

























Icon	Meaning of the Drawing Tool Box
	Select foreground and background colors
	Eraser
	Pick color
	Pencil for writing and drawing lines
	Airbrush
	Line
	Curve
	Rectangle
	Ellipse
	Polygon
	Rounded rectangle
	Text
	Select
	Fill with color
	Magnifier
	Brush
Icon	Meaning of the Drawing Toolbar
	New document
	Open
	Save

Image Wizard

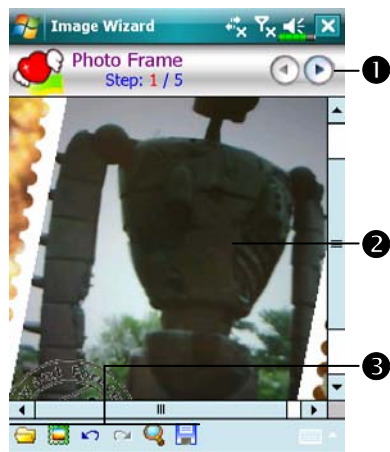
Tap , **Programs, Multimedia**, and then **Image Wizard**.

Image Wizard provides frames, icons, filters and simple drawing tools that you can use to process photos and pictures. Wizard will guide you to complete the process step-by-step. You can then choose to save the file or send it through E-mail or **MMS Message**.



- 1 Go to the next step.
- 2 Preview area
- 3  **Select Background Picture:**
Select an existing photo or picture.
For example, a photo you have taken.
 **Select Photo Frame**
 **Undo**
 **Repeat**
 **Full Screen.** Tap **ok** to return.
 **Save**

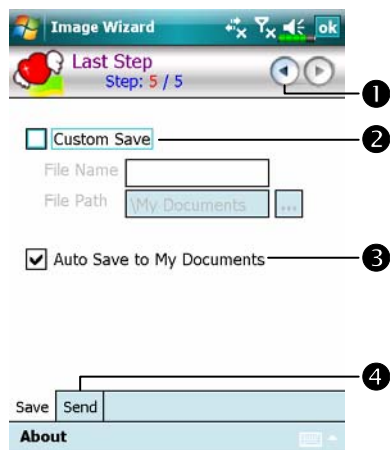

- 1 Return to the previous step.
- 2 Input a name for the file and select the file saving path.
- 3 Use system name and save to the specified path.
- 4 **Send** tab: Send through E-mail or **MMS Message**.

FM Tuner

Tap , **Programs, Multimedia**, and then **FM Tuner**.

This program is for listening to the radio with headset. The headset will improve radio quality with its built-in antenna.



1 Tool bar:

① Screen off: This function turns off the screen but leaves the program running. Turn on the power to activate the screen. When the Pocket PC enters sleep mode, the system will shut down the program.

② My Favorite: Manage My favorite radio station list.

③ Band: Change the band frequency. Use the function to change the local band rate when travelling overseas.

2 Show the selected band frequency.

③ Show the station frequency. Tap and edit the frequency to change the

station. The marquee below shows the relevant information from the radio station.

④ The volume setting.

⑤ Show the My favorite station list. Tap an item from the list to listen to the station. Hold an item for a few seconds to save the current station.

⑥ Turn the sound on or off.

⑦ ◀◀ or ▶▶: Seek to the first radio station.

⑧ ◀ or ▶: Set the last or next frequency.



☰ Set the station frequency.

① Tap and edit the frequency to set a custom station.

Note: The frequency must be in the legal range.

② Cancel.

③ OK.

④ Delete the previous digit.

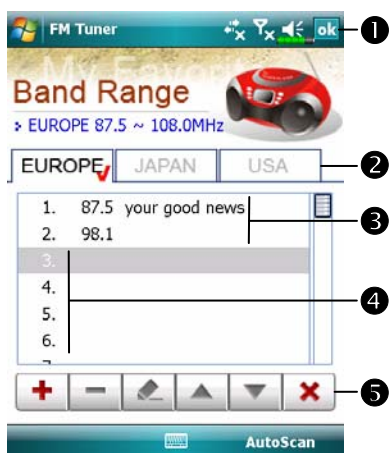

☰ Tap the **My Favorite** Button in the main screen to set My favorite station.

① Close and save the setting.

② The default value is EUROPE. To change the setting, hold the desired tab for a few seconds.

③ My favorite station list.

④ Choose an empty item and tap the  button in the tool bar to edit the station.

⑤ Tool bar:

: Add station

: Delete station

: Edit station

: Set the position in the list

: Close without saving

11 Companion Programs /

Microsoft® Pocket Outlook includes **Calendar**, **Contacts**, **Tasks**, **Messaging**, and **Notes**. You can use these programs individually or together. For example, e-mail addresses stored in **Contacts** can be used to address e-mail messages in **Messaging**.

Using synchronization tools, you can synchronize information in Microsoft Outlook or Microsoft Exchange on your desktop computer with your Pocket PC. You can also synchronize this information directly with a Microsoft Exchange server. Each time you synchronize, synchronization tools compare the changes you made on your Pocket PC and desktop computer or server and updates both computers with the latest information. For information on using synchronization tools, see Help on the desktop computer.

You can switch to any of these programs by tapping them on the  menu.

Calendar: Scheduling Appointments and Meetings

Use **Calendar** to schedule appointments, including meetings and other events. You can check your appointments in one of several views (Agenda, Day, Week, Month, and Year) and easily switch views by using the **View** menu.

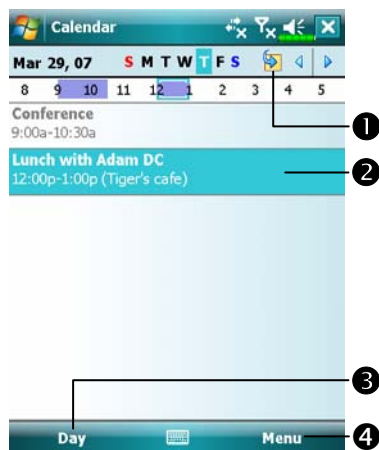

- 1 Tap to go to today.
- 2 Tap to display or edit the appointment details.
- 3 **View** menu.
- 4 Tap **Menu** and then **New Appointment** to create a new appointment.

▣ You can customize the Calendar display, such as changing the first day of the week, by tapping **Menu**, **Tools**, and then **Options**.

Create an Appointment

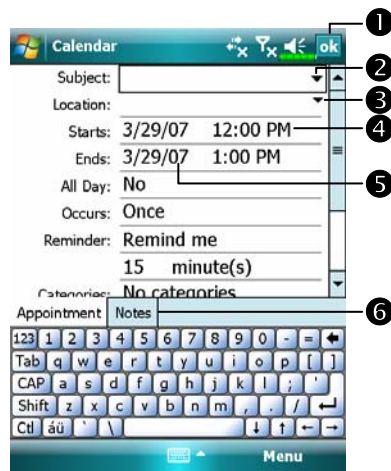

- 1 Tap to return to the calendar (the appointment is saved automatically).
- 2 Tap to choose from predefined text.
- 3 Tap to choose from previously entered locations.
- 4 Tap to select a time.
- 5 Tap to select a date.
- 6 Notes is a good place for maps and directions.

1. If you are in Day or Week view, tap the desired date and time for the appointment.
 2. Tap **Menu** and then **New Appointment**.
 3. Using the input panel, enter a description and a location. Tap first to select the field.
 4. If needed, tap the date and time to change them.
 5. Enter other desired information. You will need to hide the input panel to see all available fields.
 6. To add notes, tap the **Notes** tab. You can enter text, draw, or create a recording. For more information on creating notes, see “Notes: Capturing Thoughts and Ideas” section.
 7. When finished, tap **ok** to return to the calendar.
- ☑ If you select **Remind me** in an appointment, your Pocket PC will remind you according to the options set in , **Settings**, the **Personal** tab, **Sounds & Notifications**.

Use the Summary Screen

When you tap an appointment in **Calendar**, a summary screen is displayed. To change the appointment, tap **Edit**.

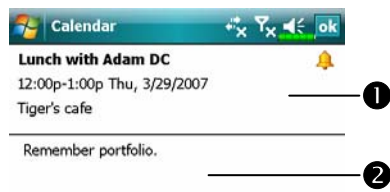

- 1 View appointment details.
- 2 View.
- 3 Tap **Menu** and then **Edit** to change appointment.



Create Meeting Requests

You can use **Calendar** to set up meetings with users of Outlook or Pocket Outlook. The meeting request will be created automatically and sent either when you synchronize Inbox or when you connect to your e-mail server. Indicate how you want meeting requests sent by tapping **Menu**, **Tools**, and then **Options**.

Schedule a Meeting

1. Create an appointment.
2. In the appointment details, hide the input panel, and then tap **Attendees**.
3. From the list of e-mail addresses you've entered in **Contacts**, select the meeting attendees.

The meeting notice is created automatically and placed in the Outbox folder.

For more information on sending and receiving meeting requests, see **Calendar Help** and **Messaging Help** on the Pocket PC.

Contacts: Tracking Friends and Colleagues

Contacts maintains a list of your friends and colleagues so that you can easily find the information you're looking for, whether you're at home or on the road.

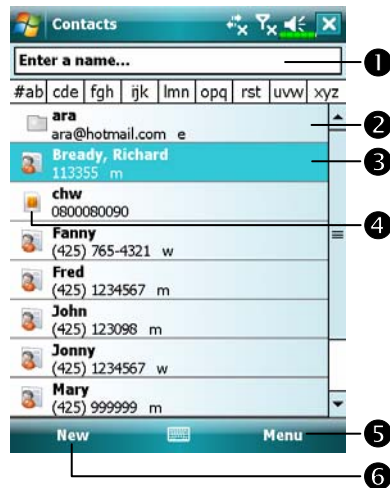

- 1 Tap and enter part of a name to quickly find it in the list.
- 2 Tap to display the contact details.
- 3 Tap and hold to display a pop-up menu of actions.
- 4 This icon indicates that this particular contact entry is stored on your SIM card, so some of the information you will only be able to modify when the mobile phone is turned on.
- 5 Provides the relevant menu. For example, select **Options** to change the way information is displayed in the list.
- 6 Tap to create a new contact.

Create a Contact

1. Tap **New**. And then select a contact type.
2. Using the input panel, enter a name and other contact information. You will need to scroll down to see all available fields.
3. To assign the contact to a category, scroll to and tap **Categories** and select a category from the list. In the contact list, you can display contacts by category.
4. To add notes, tap the **Notes** tab. You can enter text, draw, or create a recording. For more information on creating notes, see “Notes: Capturing Thoughts and Ideas” section.
5. When finished, tap **ok** to return to the contact list.



- 1 Tap to return to the contact list (the contact is saved automatically).
- 2 Tap to select a representative picture for this contact, when dialing, this picture will appear on your screen, making it easier to identify the contact which you are dialing to and adding a lot of fun.
- 3 Scroll to see more fields.
- 4 Notes is a good place for maps and directions.

Find a Contact

There are four ways to find a contact:

- In the contact list, enter a contact name in the box under the navigation bar. To show all contacts again, clear text from the box or tap the button to the right of the box.
- In the contact list, tap **Menu, Filter** and then select the type of contact that you want displayed. To show all contacts again, select **All Contacts**. To view a contact not assigned to a category, select **No Categories**.
- To view the names of companies your contacts work for, in the contact list, tap **Menu, View By** and then **Company**. The number of contacts that work for that company will be displayed to the right of the company name.
- Tap , **Programs**, and then **Search**, enter the contact name, select **Contacts** for the type, and then tap **Search**.

Use the Summary Screen

When you tap a contact in the contact list, a summary screen is displayed.

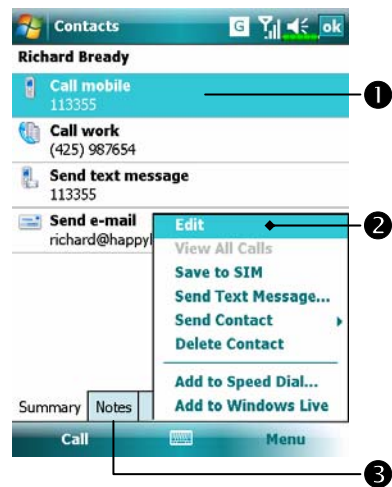

- 1 View contact details. All of the available contact information is listed, you can tap and use easily.
- 2 Provides the relevant menu. For example, select **Edit** to change the contact information. Or select **Save to SIM** or **Save to Contacts** to duplicate to **Contacts** or SIM phonebook.
- 3 Tap to view notes.

Tasks: Keeping a To Do List

Use **Tasks** to keep track of what you have to do.

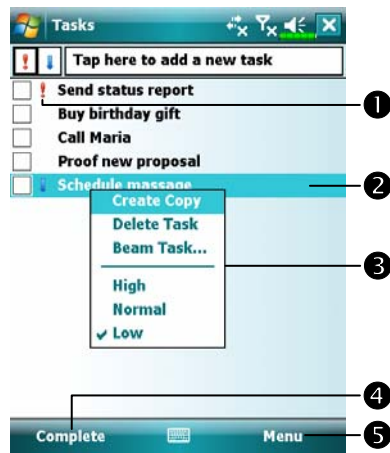

- ❶ Indicates high priority.
- ❷ Tap to display or edit the task details.
- ❸ Tap and hold to display a pop-up menu of actions.
- ❹ Tap to change the status.
- ❺ Provides the relevant menu.

For example, tap **Filter** to select the category of tasks you want displayed in the list. Tap **Sort By** to select the sort order of the list. Or tap **Options** to change the way information is displayed in the list.

Create a Task

1. Tap **Menu** and then **New Task**.
2. Using the input panel, enter a description.
3. You can enter a start date and due date or enter other information by first tapping the field. If the input panel is open, you will need to hide it to see all available fields.
4. To assign the task to a category, tap **Categories** and select a category from the list. In the task list, you can display tasks by category.
5. To add notes, tap the **Notes** tab. You can enter text, draw, or create a recording. For more information on creating notes, see “Notes: Capturing Thoughts and Ideas” section.
6. When finished, tap **ok** to return to the task list.

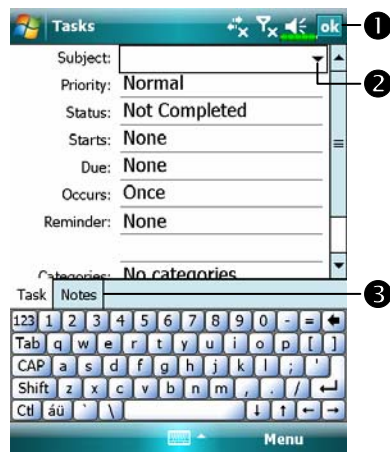

- 1 Tap to return to the task list (the task is saved automatically).
- 2 Tap to choose from predefined subjects.
- 3 Notes is a good place for maps and drawings.

▣ To quickly create a task with only a subject, check **Show Tasks entry bar** on the **Options** menu. Then, tap “Tap here to add a new task” and enter your task information.

Use the Summary Screen

When you tap a task in the task list, a summary screen is displayed. To change the task, tap **Edit**.

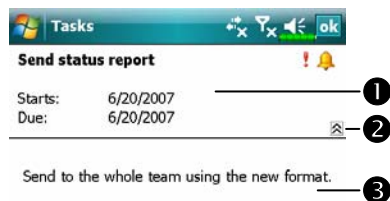

- 1 View task details.
- 2 Tap to show and hide additional summary information.
- 3 View notes.
- 4 Tap to change task.



Notes: Capturing Thoughts and Ideas

Quickly capture thoughts, reminders, ideas, drawings, and phone numbers with **Notes**. You can create a written note or a recording. You can also include a recording in a note. If a note is open when you create the recording, it will be included in the note as an icon. If the note list is displayed, it will be created as a stand-alone recording.

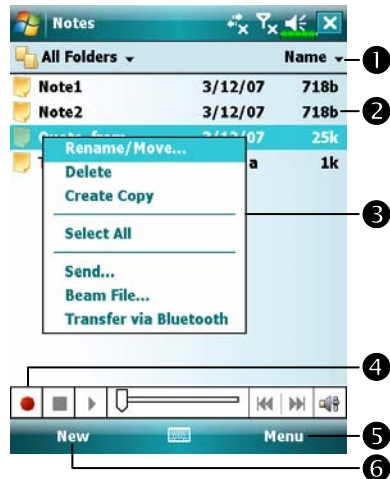

- 1 Tap to change the sort order of the list.
- 2 Tap to open a note or play a recording.
- 3 Tap and hold to display a pop-up menu of actions.
- 4 Tap to record.
- 5 Provides the relevant menu. For example, check **View Recording Toolbar** to show the Recording toolbar.
- 6 Tap to create a new item.

Create a Note

1. Tap **New**.
2. Create your note by writing, drawing, typing, and recording. For more information about using the input panel, writing and drawing on the screen, and creating recordings, see “Enter Information on Your Pocket PC.”

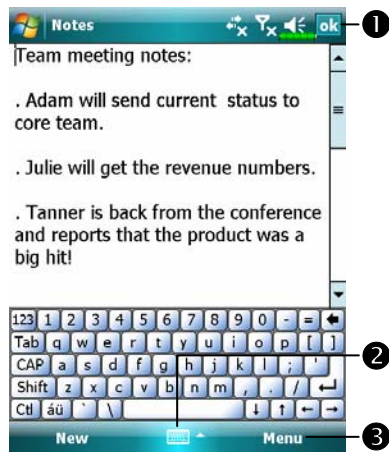

❶ Tap to return to the note list (the note is saved automatically).

❷ Tap to show or hide the input panel.

❸ Provides the relevant menu.

For example, check **View**

Recording Toolbar to add a recording to the note; or check

Draw to write on the screen.

Word Mobile

Word Mobile works with Microsoft Word on your desktop computer to give you easy access to copies of your documents. You can create new documents on your Pocket PC, or you can copy documents from your desktop computer to your Pocket PC. Synchronize documents between your desktop computer and your Pocket PC so that you have the most up-to-date content in both locations.

Use Word Mobile to create documents, such as letters, meeting minutes, and trip reports. To create a new file, tap , **Office Mobile, Word Mobile**, and then **New**. A blank document appears. Or, if you've selected a template for new documents in the **Options** dialog box, that template appears with appropriate text and formatting already provided. You can open only one document at a time; when you open a second document, you'll be asked to save the first. You can save a document you create or edit in a variety of formats, including Word Document (.doc), Document Template (.dot), Rich Text Format (.rtf), and Plain Text (.txt).

Word Mobile contains a list of the files stored on your Pocket PC. Tap a file in the list to open it. To delete, make copies of, and send files, tap and hold a file in the list. Then, select the appropriate action on the pop-up menu.

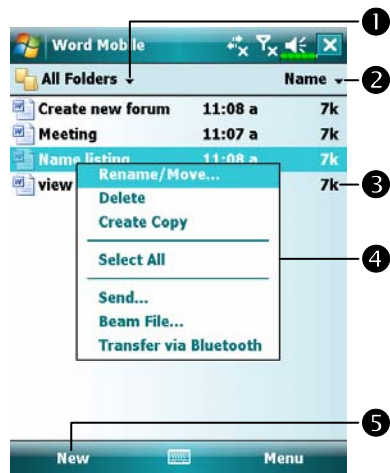

- ❶ Select the type of folder you want displayed in the list.
- ❷ Tap to change the sort order of the list.
- ❸ Tap to open a document.
- ❹ Tap and hold an item to see a pop-up menu of actions.
- ❺ Tap to create a new document.

☒ You can change the zoom magnification by tapping **View** and then **Zoom**. Then select the percentage you want. Select a higher percentage to enter text and a lower one to see more of your document.

If you're opening a Word document created on a desktop computer, check **Wrap to Window** on the **View** menu so that you can see the entire document.

Using the input panel, enter typed text into the document. For more information on entering typed text, see “Enter Information on Your Pocket PC.”

To format existing text and to edit text, first select the text. You can select text as you do in a Word document, using your stylus instead of the mouse to drag through the text you want to select. You can search a document to find text by tapping **Menu**, **Edit** and then **Find/Replace**.

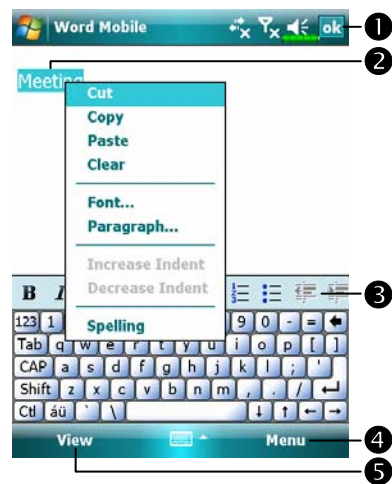

- ❶ Tap to return to the document list (changes are saved automatically).
- ❷ Tap and hold to see a pop-up menu of actions.
- ❸ Tap to format text.
- ❹ Provides the relevant menu. For example, select **Format** to change formatting options.
- ❺ Tap **View** and then check **Toolbar** to show the toolbar.

Excel Mobile

Excel Mobile works with Microsoft Excel on your desktop computer to give you easy access to copies of your workbooks. You can create new workbooks on your Pocket PC, or you can copy workbooks from your desktop computer to your Pocket PC. Synchronize workbooks between your desktop computer and your Pocket PC so that you have the most up-to-date content in both locations.

Use Excel Mobile to create workbooks, such as expense reports and mileage logs. To create a new file, tap , **Office Mobile**, **Excel Mobile**, and then **New**. A blank workbook appears. Or, if you've selected a template for new workbooks in the **Options** dialog box, that template appears with appropriate text and formatting already provided. You can open only one workbook at a time; when you open a second workbook, you'll be asked to save the first.

Excel Mobile contains a list of the files stored on your Pocket PC. Tap a file in the list to open it. To delete, make copies of, and send files, tap and hold a file in the list. Then select the appropriate action from the pop-up menu.

Excel Mobile provides fundamental spreadsheet tools, such as formulas, functions, sorting, and filtering. To display the toolbar, tap **View** and then check **Toolbar**.

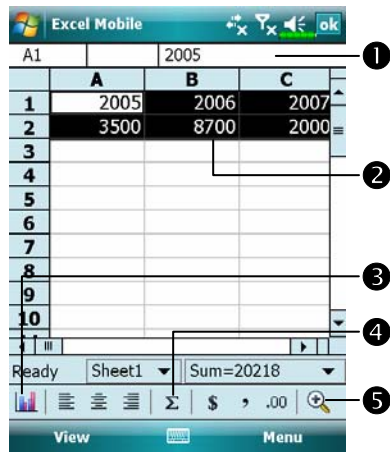

- ❶ Cell contents appear here as you enter them.
- ❷ Select cell contents for the resource of chart.
- ❸ **Insert Chart** Button
- ❹ **AutoSum** Button
- ❺ **Zoom** Button

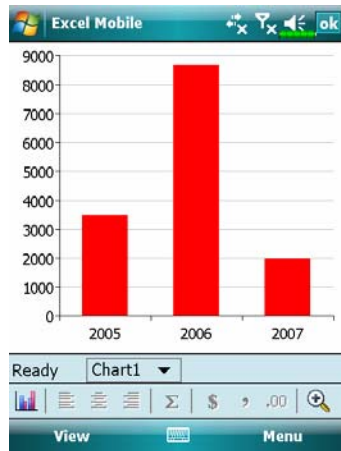

- Ⓢ Tap **Format Chart** Button to modify the relevant information, such as titles, scale, type and series.

Tips for Working in Excel Mobile

For more information on using Excel Mobile, tap  and then **Help**.
Note the following when working in large worksheets in Excel Mobile:

- View in full-screen mode to see as much of your worksheet as possible.
Tap **View** and then check **Full Screen**. To exit full-screen mode, tap **View** and then **Full Screen** to restore.
- Show and hide window elements. Tap **View, Show** and then tap the elements you want to show or hide.
- Freeze panes on a worksheet. First select the cell where you want to freeze panes. Tap **View** and then **Freeze Panes**. You might want to freeze the top and leftmost panes in a worksheet to keep row and column labels visible as you scroll through a sheet.
- Split panes to view different areas of a large worksheet. Tap **View** and then **Split**. Then drag the split bar to where you want it. To remove the split, tap **View** and then **Remove Split**.
- Show and hide rows and columns. To hide a row or column, select a cell in the row or column you want to hide. Then tap **Menu, Format**, then **Row** or **Column**, and then **Hide**. To show a hidden row or column, tap **Menu, Format**, then **Row** or **Column**, and then **Unhide**.

PowerPoint Mobile

View PowerPoint slides created in PowerPoint 97 and above versions on your desktop computer. The supported formats include .ppt and .pps files.

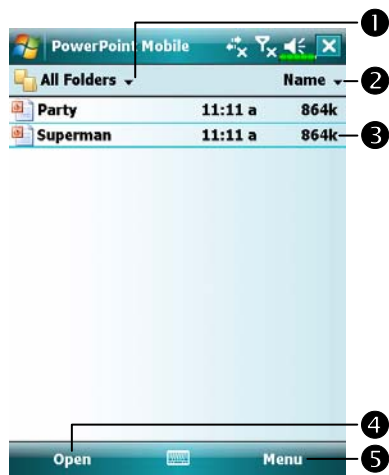

- ❶ Select the type of folder you want displayed in the list.
- ❷ Tap to change the sort order of the list.
- ❸ Tap to open a file, and play the slides.
- ❹ Tap to open the file you played last time.
- ❺ Provides the relevant menu.

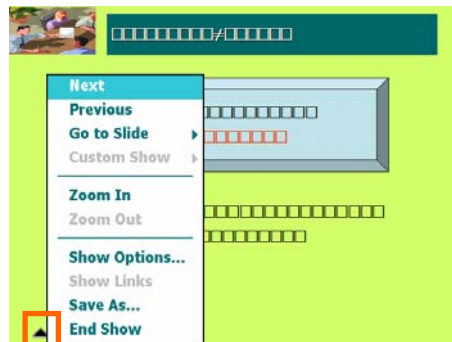

- ⌂ Tap ▲| on the lower left corner to open the menu.
- Tap **End Show** to quit.

Windows Media Player

Use Microsoft Windows Media Player for Pocket PC to play digital audio and video files that are stored on your Pocket PC or on a network. To switch to Windows Media Player for Pocket PC, tap  and then

Windows Media.



- ① Use full-screen to view video.
- ② Display website. Find music or video to be played from website.
- ③ Return to the start of the current file or previous file.
- ④ Tap to play or pause.
- ⑤ Tap to skip to the next song.
- ⑥ Tap to adjust volume.
- ⑦ Audio/mute
- ⑧ Indicates the progress of the current track.

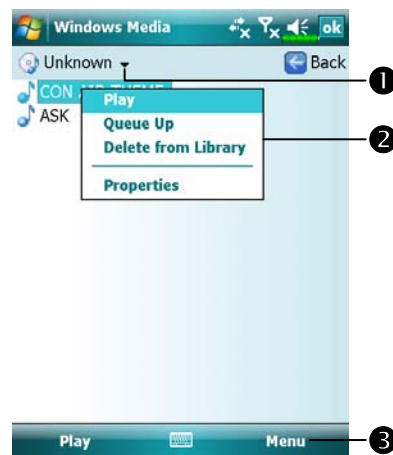

- ⌂ To enter the screen shown on the left, tap **Menu** and then **Library**.
- ① Select **Library**.
- ② Tap and hold the file or folder to be played, then tap **Play** or **Queue Up**.
- ③ **Menu Button:** Tap **Open File** to play files that do not belong to the current library. Tap **Update Library** to update the file list.

Use Microsoft Windows Media Player on your desktop computer to copy digital audio and video files to your Pocket PC. You can play Windows Media and MP3 files on your Pocket PC.

For more information about using Windows Media Player for Pocket PC, tap , and then tap **Help**.

Internet Explore

Using Internet Explore

Use Microsoft® Internet Explorer Mobile to view Web or WAP pages in either of these ways:

- During synchronization with your desktop computer, download your favorite links and mobile favorites that are stored in the Mobile Favorites subfolder in Internet Explorer on the desktop computer.
- Connect to an Internet service provider (ISP) or network and browse the Web. To do this, you'll need to create the connection first, as described in "Connect to the Internet".

When connected to an ISP or network, you can also download files and programs from the Internet or intranet.

To switch to Pocket Internet Explorer, tap  and then **Internet Explorer**.

Browse the Internet

Refer to “Connecting to the Internet” section to connect the Pocket PC to the Internet and start browsing websites.

1. Tap  and then **Internet Explorer**.
2. Input the site address into the address bar at the top of the screen and connect to this site.
3. Use the scroll bar at the right side or bottom of the screen, or press the up or down button on the Pocket PC to view the contents of the entire website.

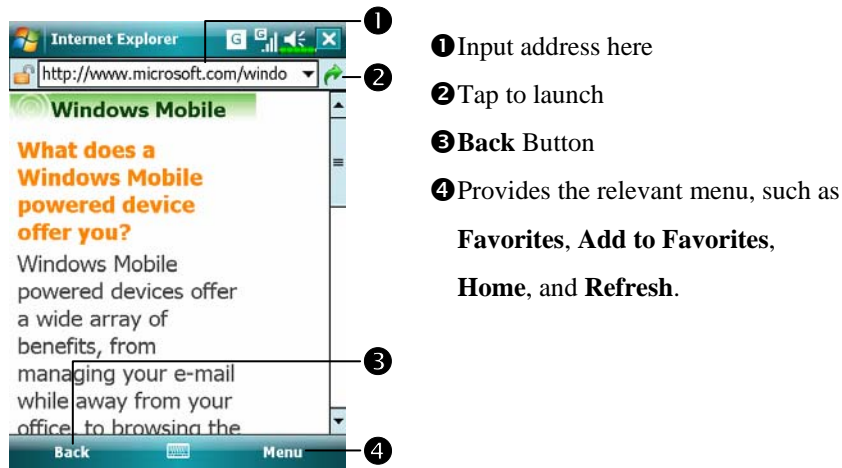

Aside from keying in the address directly, you can also connect to websites using the following methods.

- Tap the **Favorites** button, and then tap the favorite you want to view.
- In the address bar, tap the arrow ▼ to choose from previously entered addresses.
- To add a favorite link while using the Pocket PC, go to the page you want to add, tap and hold on the page, and tap **Add to Favorites**.

View Mobile Favorites and Channels



- 1 Tap the favorite you want to view.
- 2 Tap to add or delete a folder or favorite link.



1. Tap the **Favorites** button to display your list of favorites.
2. Tap the page you want to view.

You'll see the page that was downloaded the last time you synchronized with your desktop computer. If the page is not on your Pocket PC, the favorite will be dimmed. You will need to synchronize with your desktop computer again to download the page to your Pocket PC, or connect to the Internet to view the page.

The Mobile Favorites Folder

Only items stored in the Mobile Favorites subfolder in the Favorites folder in Internet Explorer on your desktop computer will be synchronized with your Pocket PC. This folder was created automatically when you installed synchronization tools.

Favorite Links

During synchronization, the list of favorite links in the Mobile Favorites folder on your desktop computer is synchronized with Pocket Internet Explorer on your Pocket PC. Both computers are updated with changes made to either list each time you synchronize. Unless you mark the favorite link as a mobile favorite, only the link will be downloaded to your Pocket PC, and you will need to connect to your ISP or network to view the content. For more information on synchronization, see Help on the desktop computer.

Synchronize Mobile Favorites

If you are using Microsoft Internet Explorer 5.0 or later on your desktop computer, you can download mobile favorites to your Pocket PC. Synchronizing mobile favorites downloads Web content to your Pocket PC so that you can view pages while you are disconnected from your ISP and desktop computer.

Use the Internet Explorer plug-in installed with synchronization tools to create mobile favorites quickly.

Create a Mobile Favorite

1. In Internet Explorer on your desktop computer, click **Tools** and then **Create Mobile Favorite**.
2. To change the link name, enter a new name in the **Name** box.
3. Optionally, in **Update**, select a desired update schedule.
4. Click **OK**. Internet Explorer downloads the latest version of the page to your desktop computer.

5. Synchronize your Pocket PC and desktop computer. Mobile favorites that are stored in the Mobile Favorites folder in Internet Explorer are downloaded to your Pocket PC.

▣ If you did not specify an update schedule in step 3, you will need to manually download content to keep the information updated on your desktop computer and Pocket PC. Before synchronizing with your Pocket PC, in Internet Explorer on your desktop computer, click **Tools** and then **Synchronize**. You will see the last time content was downloaded to the desktop computer, and you can manually download content if needed. You can add a button to the Internet Explorer toolbar for creating mobile favorites. In Internet Explorer on your desktop computer, click **View**, **Toolbars**, and then **Customize**.

Save Pocket PC Memory

Mobile favorites take up storage memory on your Pocket PC. To minimize the amount of memory used:

- ✿ In the settings for the Favorites information type in synchronization tools options, turn off pictures and sounds, or stop some mobile favorites from being downloaded to the Pocket PC. For more information, see **Help**.
- ✿ Limit the number of downloaded linked pages. In Internet Explorer on the desktop computer, right-click the mobile favorite you want to change and then **Properties**. In the **Download** tab, specify 0 or 1 for the number of linked pages you want to download.

12 Maintaining the Pocket PC

Backup Utility

 Tap , **Programs, Utilities**, and then **Backup Utility**.

Backup Utility is used to back up or restore files saved in the Pocket PC. You can back up personal data such as **Calendar, Contacts, Tasks, Personal profile, Network settings, Messaging** (E-mails and SMS), etc.

Storage Space

When making backups, you can choose the following storage spaces:

1. My Documents: Data saved here may disappear when you perform a cold boot. It is recommended that you use this area only as temporary storage.
2. External storage card

Backup Files

Wizard Mode



- 1 Tap **Backup**.
- 2 Tap **Next** Button and the Wizard will guide through the steps that follow.
- 3 **Standard**: Switch to the Standard mode.

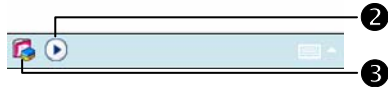

Standard Mode

Backup your personal data to a storage space.

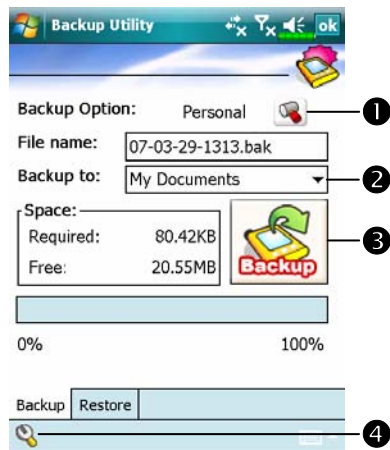

- 1 Tap the **Backup** tab.
- 1 Tap to check the items for backup.
- 2 Tap to select the storage space from the list.
- 3 Tap **Backup** Button to start the backup.
- 4 **Advanced** Button: Enter the Advanced settings screen.

Advanced Settings Options

Under the Backup Files screen, tap  **Advanced** Button to enter the Advanced settings screen as shown below.





☐ Check the options as required.

❶ If you check this option, the Wizard will guide you through the steps to complete the operation the next time you open **Backup Utility**.

❷ **Cancel** Button

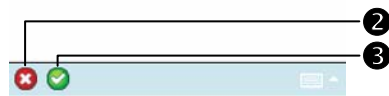
❸ **OK** Button



☐ If you checked “Auto backup files,” tap  to enter the screen shown on the left.

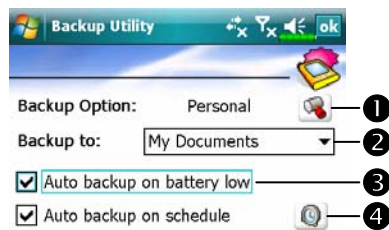



❶ Select the backup option.

❷ Select the site to backup to.

❸ Pocket PC performs auto backup when the battery power is low.

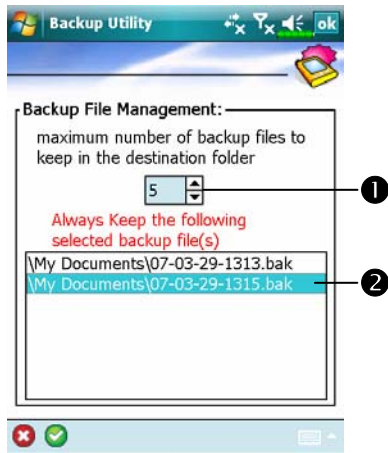
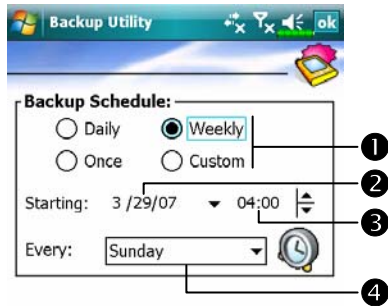
❹ To backup regularly, tap  to select “Auto Backup on schedule.”



☛ If you checked “Auto backup on schedule,” tap  to enter the screen shown on the left.

- ❶ Backup frequency.
- ❷ Tap the date button on the right of “Starting” to set the starting date.
- ❸ Tap the time button on the right of “Starting” to set the starting time.
- ❹ If you have selected “Weekly,” tap the function button on the right of “Every” to set the day of the week to backup.

☛ If you selected “Manage old backup files,” tap  to enter the screen shown on the left.

- ❶ Tap the arrowhead to set the number of files.
- ❷ Tap the files to be retained.



Restore Files

Caution!

1. When restoring files, the system will delete all current data in the Pocket PC and replace it with the backup files.
2. To make sure that files can be restored successfully, do not use the Pocket PC while performing restore.
3. Restore cannot be stopped once it is started. Think carefully before proceeding.
4. After restore completed, your Pocket PC will reboot.

Wizard Mode



- 1 Tap **Restore**.
- 2 Tap  **Next** Button and the Wizard will guide through the steps that follow.
- 3  **Standard**: Switch to the Standard mode.

Standard Mode

Restore the backup personal data from a storage space.

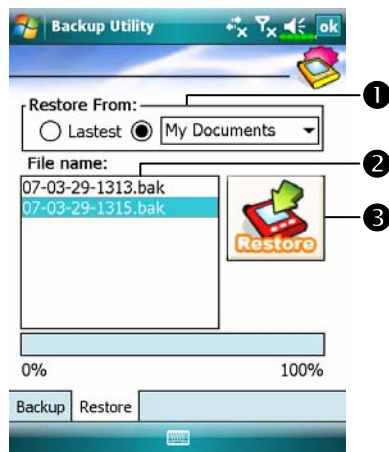

Tap the **Restore** tab.

- 1 Select “Latest” below “Restore From.” Or select from the list.
- 2 Tap backup file name from the list under “File Name.”
- 3 Tap  **Restore** Button to start restoring.

Adding or Removing Programs

Programs added to your Pocket PC at the factory are stored in ROM (read-only memory). You cannot remove this software, and you'll never accidentally lose ROM contents. All other programs and data files added to your Pocket PC after factory installation are stored in RAM (random access memory).

You can install any program created for your Pocket PC, as long as your Pocket PC has enough memory. The most popular place to find software for your Pocket PC is on the Pocket PC Web site (<http://www.microsoft.com/windowsmobile/pocketpc/>).

Add Programs Using Synchronization Tools

You'll need to install the appropriate software for your Pocket PC on your desktop computer before installing it on your Pocket PC.

1. Determine your Pocket PC and processor type so that you know which version of the software to install. Tap  and then **Settings**. On the **System** tab, tap **About**. In the **Version** tab, make a note of the information in **Processor**.
2. Download the program to your desktop computer (or insert the CD or disk that contains the program into your desktop computer). You may see a single *.xip, *.exe, or *.zip file, a Setup.exe file, or several versions of files for different Pocket PC types and processors. Be sure to select the program designed for the Pocket PC and your Pocket PC processor type.
3. Read any installation instructions, Read Me files, or documentation that comes with the program. Many programs provide special installation instructions.
4. Connect your Pocket PC and desktop computer.

5. Double-click the *.exe file.

- ❶ If the file is an installer, the installation wizard will begin. Follow the directions on the screen. Once the software has been installed on your desktop computer, the installer will automatically transfer the software to your Pocket PC.
- ❷ If the file is not an installer, you will see an error message stating that the program is valid but it is designed for a different type of computer. You will need to move this file to your Pocket PC. If you cannot find any installation instructions for the program in the Read Me file or documentation, use synchronization tools **Explore** to copy the program file to the Program Files folder on your Pocket PC. For more information on copying files using synchronization tools, see Help.

Once installation is complete, tap , **Programs**, and then the program icon to switch to it.

Add a Program Directly from the Internet

1. Determine your Pocket PC and processor type so that you know which version of the software to install. Tap  and then **Settings**. On the **System** tab, tap **About**. In the **Version** tab, make a note of the information in **Processor**.
2. Download the program to your Pocket PC straight from the Internet using Pocket Internet Explorer. You may see a single *.xip, *.exe or *.zip file, a Setup.exe file, or several versions of files for different Pocket PC types and processors. Be sure to select the program designed for the Pocket PC and your Pocket PC processor type.
3. Read any installation instructions, Read Me files, or documentation that comes with the program. Many programs provide special installation instructions.
4. Tap the file, such as a *.xip or *.exe file. The installation wizard will begin. Follow the directions on the screen.

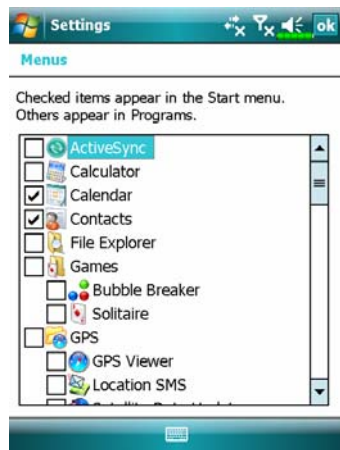

Add a Program to the Start Menu

Tap , **Settings**, the **Personal** tab, and then **Menus**.



Check the box for the program.

If you do not see the program listed, you can either use **File Explorer** on the Pocket PC to move the program to the Start Menu folder, or use synchronization tools on the desktop computer to create a shortcut to the program and place the shortcut in the Start Menu folder.

Using File Explorer on the Pocket PC: Tap , **Programs**, **File Explorer**, and locate the program (tap the folder list, labeled **My Documents** by default, and then **My Device** to see a list of all folders on the Pocket PC). Tap and hold the program and tap **Cut** on the pop-up menu. Open the **Start Menu** folder located in the **Windows** folder, tap and hold a blank area of the window, and tap **Paste** on the pop-up menu. The program will now appear on the  menu.

⚙️ Using synchronization tools on the desktop computer: Use the Explorer in synchronization tools to explore your Pocket PC files and locate the program. Right-click the program, and then click **Create Shortcut**. Move the shortcut to the **Start Menu** folder in the **Windows** folder. The shortcut now appears on the  menu. For more information, see Help.

Remove Programs

👤 Tap  and then **Settings**. On the **System** tab, tap **Remove Programs**.

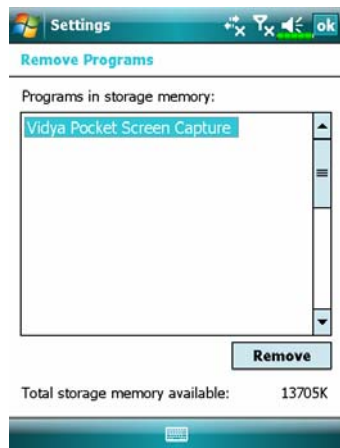

👉 Tap a program name from the list under “Programs in storage memory” to highlight it and then tap **Remove**.

If the program does not appear in the list of installed programs, use **File Explorer** on your Pocket PC to locate the program, tap and hold the program, and then tap **Delete** on the pop-up menu.

Manage Memory

View Memory Status

Tap , **Settings**, the **System** tab, and then **Memory**.

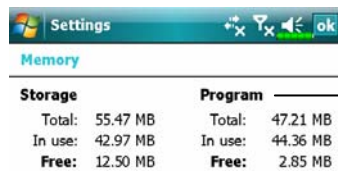

Tap the **Main** tab.

1 The status of Storage and Program memory.

2 Find: Quick link to the **Search** program.

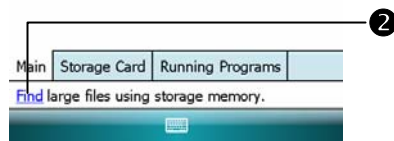

2

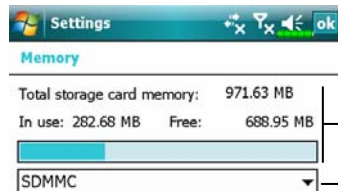

Tap the **Storage Card** tab.

1 Current storage card memory status.

2 Tap to select the built-in or external storage card.



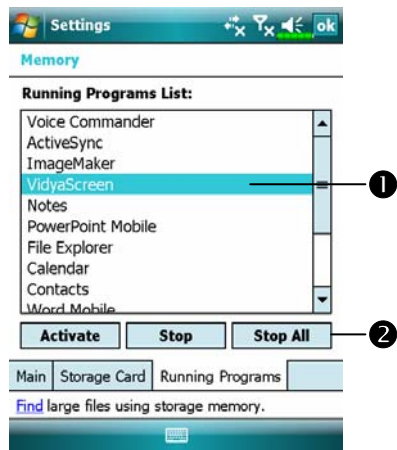

Tap the **Running Programs** tab.

1 Tap a program name in "Running Programs List" and when it is highlighted, tap **Activate** or **Stop**.

2 **Activate**: Start running the program you selected.

Stop: Stop the program you selected.

Stop All: Stop all programs in the "Running Programs List."

Find Available Memory

Under certain circumstances such as insufficient memory, the Pocket PC cannot allocate memory automatically. Try to solve this problem through the following methods:

Tap , **Programs**, and then **Search**.

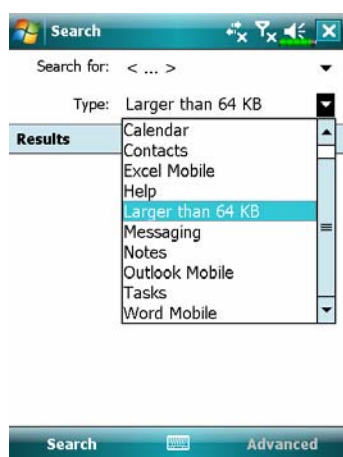

1. To find files occupying larger amounts of memory, select "Larger than 64 KB" for type and tap **Search**.

2. Then use **File Explorer**.

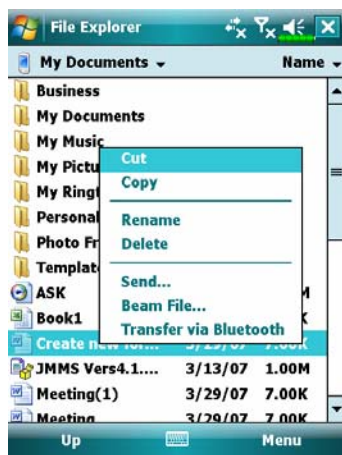

3. Tap , **Programs**, and then **File Explorer**. Use **File Explorer** to move the files you want to keep to external storage cards. Tap and hold the items to be moved, then tap **Cut** or **Copy** on the pop-up menu. Move to the storage card and then tap **Paste**.

4. Use **File Explorer** to delete files that you no longer need.

Tap , **Messaging**, **Menu**, **Tools**, **Options**, and then the **Storage** tab.

☑ Check “Store attachments on storage card” to save attached files from E-mails automatically in the storage card in future.

Tap , **Internet Explorer**, **Menu**, **Tools**, and then **Options**.

☑ Tap **Clear History** and **Delete Files** to delete records of websites that you have browsed.

Tap , **Programs, Notes/Word Mobile/Excel Mobile, Menu,** and then **Options.**



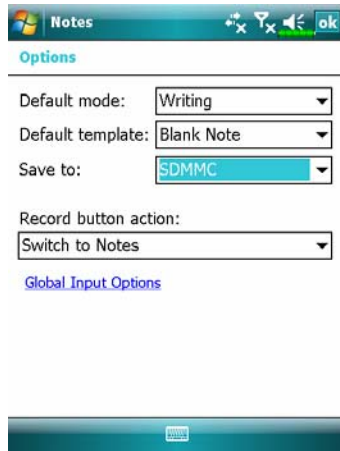

1. Enter the **Notes** file list screen.
2. Tap **Menu** and then **Options.**





3. Tap the “Save to” function button and select SDMMC from the list. This indicates that you are using your external storage card. Hereafter, new files will be automatically saved to this storage card.
- Follow the same operation procedure for **Notes** in **Word Mobile** and **Excel Mobile.**

In addition, you can use the **Rename/Move** or **Save As** function provided by the program above to move or save files to the storage card.

System Information

Tap  Tap , **Settings**, the **System** tab, and then **System Information**.



Tap  or  to display or hide the system information.

13 Voice Commander /

Tap , **Programs** and then **Voice Commander**.

Voice Commander is continuous voice recognition application software in the Pocket PC. **Voice Commander** allows the user to use their own voice to dial and control functions. **Voice Commander** has the following features:

- Fully voice-controlled system that allows the user to complete operations (such as dialing phone or running applications) quickly without using hands.
- Uses Speaker-Independent (SI) recognition technology that allows the user to use the Pocket PC immediately without having to train or pre-record for the system.
- Provides a Conversational UI for guiding beginners to issue voice commands through the conversational method. The user can then use commands easily without any practice.
- Provides the Voice tag and “digit model adaptation” function so that the user can customize personal settings and further increase recognition and convenience in usage.

The **Voice Commander** provided with this product does not need personal training or recording. You can use voice control to operate this Pocket PC immediately. Try calling out “Solitaire” to play. Tap the **Voice Commander** Button on the side of the Pocket PC and when the system prompts you to “Say Command,” just say “Start Solitaire” and the **Solitaire** game screen will appear.

Starting Voice Commander

Here are two methods for running **Voice Commander**:

1. Tap , **Programs**, **Voice Commander**, and then **Voice Commander**.
2. **Voice Commander** Button. The system sets the button on the Pocket PC as the exclusive “Voice Commander” button. Just press this button to run **Voice Commander**.

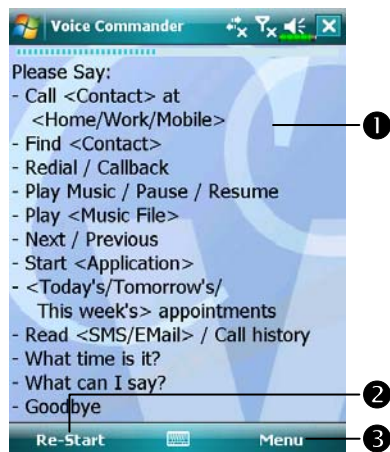

- 1 Show the format of voice command.
- 2 Re-Start Button: Restart **Voice Commander**.
- 3 Menu Button:
 - Settings:** Setup **Voice Commander**.
 - Help:** About **Voice Commander**.
 - Exit:** Exit **Voice Commander**.



Tap , **Settings**, the **Personal** tab, and then **Buttons** to redefine the **Voice Commander** hot key or other hardware buttons.

Voice Command Format

 Press the **Voice Commander** Button on the Pocket PC and enter the **Voice Commander** screen.

■ **Voice Name dialing**

Usage: Call <Contact> at <Home/Work/Mobile>

Example 1: *Call Jennifer Lopez*

Example 2: *Call Jennifer Lopez at mobile*

■ **Voice Show Contact**

Usage: Show <Contact> at <Home/Work/Mobile>

Example 1: *Show Eric Clapton*

Example 2: *Show Eric Clapton at work*

■ **Voice Digit Dial**

Usage: Digit Dial

Example: Digit Dial

(System: *What number*)

29109088

■ **Start Application**

Usage: Start <Application>

Example: *Start Calendar*

■ **Voice Show Appointment**

Usage: Today's/Tomorrow's/

This week's Appointment

■ **Voice Play Music File**

Usage: Play <Music file name>

Example 1: Play The Moment

Example 2: Play SHE album

Example 3: Play Music

■ **Goodbye**

Usage: Goodbye

Tips

- All the names in **Contacts** will automatically become recognizable contacts in the “Voice dialing” syntax. However, if the number of contacts exceeds 1000 entries, the system will not recognize the excessive entries. To add these entries to **Voice Commander** for recognition, tap **Menu** and then **Settings** or run **Voice Commander Settings** to check and add these contacts manually for voice recognition.
- If your volume is too low or if your surroundings are so noisy that the system cannot recognize your voice, the system will prompt you “Please say again.” Adjust the distance between yourself and your Pocket PC or reduce the noise and try again.

Tips

If the user has a heavy accent that may cause poor voice recognition, use any of the following methods to train the personal digital adapted model in order to increase recognition:

1. Tap **Menu, Setting**, and then the **Digit Training** tab.
2. Tap **Voice Commander Settings** and then the **Digit Training** tab.

Tips

- You can also tap **Voice Commander, Menu**, and then **Exit** to end **Voice Commander**.
- If you open another program while using **Voice Commander** and it covers the **Voice Commander** screen, **Voice Commander** will terminate automatically.

Voice Commander Settings

There are two ways to run **Voice Commander Settings**:

Tap , **Programs, Voice Commander**, and then **Voice Commander Settings**.

Tap **Menu** and then **Settings** while using **Voice Commander**.

Voice Commander Settings allows the user to personalize the **Voice Commander** settings, add and remove contacts or applications within the recognition range, record voice tags or play commands to prompt the user on how to say the correct command.

Contacts Settings Page

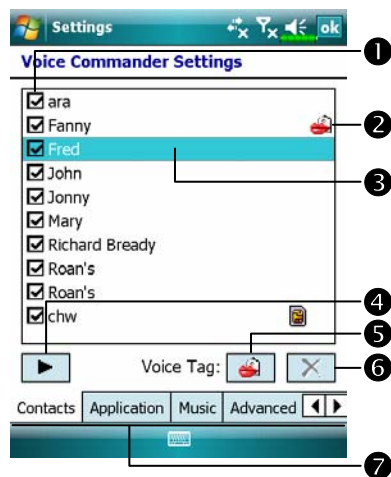

Tap **Voice Commander Settings** and then the **Contacts** tab. The setting page will list all the names and their status (whether or not it is selected, with or without voice tag) in **Contacts**.





1 Check box function

If a contact is checked, it can be identified normally. If unchecked, this indicates that it is not within the recognizable range. Please create a voice tag.

2 Lips icon: Voice tag is built.

3 Tap a contact name to highlight it for using with    buttons.

④  **Play Button:** Play the recorded voice tag for this contact and hear how it is pronounced.

⑤  **Build Button:** Record the voice tag for this contact again.

⑥  **Delete Button:** Delete the voice tag for this contact.





⑦ **Contacts** tab: Sets the voice commands for **Contacts**.

Application tab: Sets the voice commands for applications.

Digit Training tab: Sets the voice command for digital dialing.

Advanced Settings tab: Sets the length and sensitivity for digital dialing.

For example, record Alex Cooper in **Contacts** as Sweet Heart.

1. Tap Alex Cooper.
2. Tap  **Build** Button.
3. When you hear a beep, say the words “Sweet Heart” that you want to record.
4. When you hear a second beep, say “Sweet Heart” again.
5. After recording twice, the system will play the voice you just recorded to indicate that you have created a voice tag.
6. At this time, a Lips icon  appears to the right of your contact, Alex Cooper, to indicate that there is a voice tag created for this name. This is helpful in identifying which contacts already have voice tags.
7. To create another voice tag, tap  **Build** Button and repeat the steps above.
8. Tap  **Delete** Button to remove the voice tag. The system will then restore the default voice for Alex Cooper.

 Tips

- You can choose which Contacts are to be added to the recognizable range of the Voice Commander. By default, the system automatically adds all names within the recognizable range.
- If the number of **Contacts** exceeds 1000 entries, the system will not recognize the excessive entries. To add these contacts to **Voice Commander** for recognition, manually check the check boxes in front of the contact entries.

Application Settings Page

Tap **Voice Commander Settings** and then the **Application** tab and the Settings page will list the applications and settings installed by the Pocket PC on  and then **Programs** (whether or not it is selected, with or without voice tag).

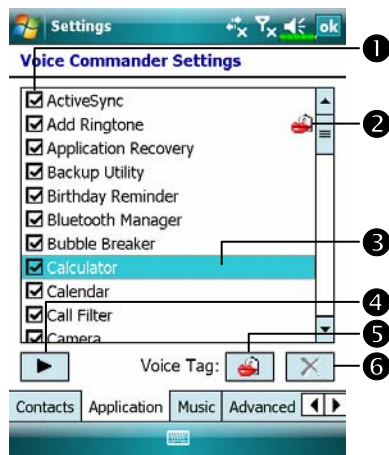

You can choose which applications are to be added to the recognizable range of the **Voice Commander**. By default, the system automatically adds all applications as recognizable targets in the < Application > syntax in “Voice open application.” No matter when you install a new application, the system updates immediately and adds the new application within the recognizable range. This helps you save time spent in finding applications.





1 Check box function

If the application is checked, it can be identified normally. If unchecked, this indicates that it is not within the recognizable range. If the check box is gray and cannot be checked, this indicates that the item is unrecognizable. Build a voice tag to add a gray item into the recognizable range.

2 Lips icon: Voice tag is built.





3 Tapped application name is highlighted and can be used with    functions.

4  **Play** Button: Play the recorded voice tag for this application and hear how it is pronounced.

5  **Build** Button: Record the voice tag for this application again.

6  **Delete** Button: If there is a Lips icon, the voice tag for this application can be deleted and restored to the default system voice.

Application example: You want to record Windows Live™ Messengers as “Chat room.”

1. Tap Windows Live™ Messengers.
2. Tap  **Build** Button.
3. When you hear a beep, say the words “Chat room” that you want to record.
4. When you hear a second beep, say “Chat room” again.
5. After recording twice, the system will play the voice you just recorded to indicate that you have created a voice tag.
6. At this time, a Lips icon  appears to the right of Windows Live™ Messengers to indicate that there is a voice tag created for this application name. This is helpful in identifying which applications already have voice tags.
7. To create another voice tag, tap  **Build** Button and repeat the steps above.
8. Tap  **Delete** Button to remove the voice tag. The system will then restore the default voice for Windows Live™ Messengers.

Music Settings Page

Tap **Voice Commander Settings** and then the **Music** tab, the settings page will list the music files and configuration status of the specify folder in your Pocket PC or on your storage card.

If you add a new music file, the system will update in real-time, automatically adding the file to your recognizable range, saving you the time of searching for your music files.

.MP3 and .WMA music file formats are supported, and the system will automatically activate all of the music files stored in the following folders:

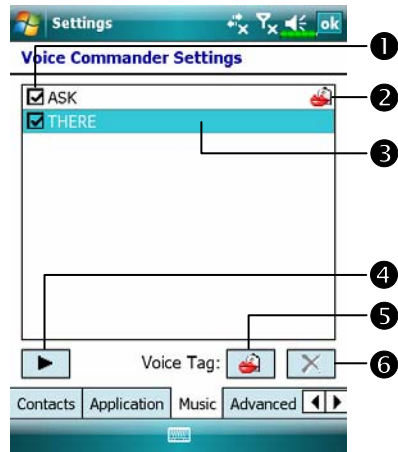

1. All folders on your storage card.
2. The **My Documents** folder in your Pocket PC, or any folder that is inside the **My Documents** folder.
3. If you want to transfer the files to your Pocket PC via the synchronization tools, then you must put the files in either the **Playlists** folder or the **Music** folder.





① Check box function

If the music file name is checked, it can be identified normally. If unchecked, this indicates that it is not within the recognizable range. If the check box is gray and cannot be checked, this indicates that the item is unrecognizable. Build a voice tag to add a gray item into the recognizable range.

②  Lips icon: Voice tag is built.

③ Tapped music file name is highlighted and can be used with    functions.

④  **Play Button:** Play the recorded voice tag for this music file name and hear how it is pronounced.

⑤  **Build Button:** Record the voice tag for this music file name again.

⑥  **Delete Button:** If there is a Lips icon, the voice tag for this music file name can be deleted and restored to the default system voice.

Tips

- As long as you have completed recording, then you can check “Use adapted model” to use the personal model tailored made for you. It is recommended that you recite all 10 sets of numbers so the adaptation effect is more obvious. If you do not want to use the adapted model, then just uncheck “Use adapted model.”
- If you have trained 10 sets of number as 1 set of voice model, the system will show that all numbers are already recorded when you run this function. If some of the numbers are not yet recorded, the system returns to where it stopped the last time to let you continue with the unfinished portion.
- You can also tap  **Remove All** Button and the system will delete the last voice model trained and let you train a new model.

Advanced Settings Page

The Sensitivity setting is for voice recognition. The “Length of phone number” setting specifies the maximum number of digits that can be entered as the phone number. These settings will improve recognition accuracy.

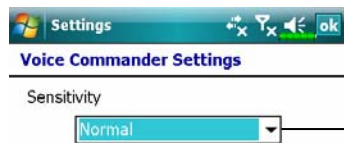

1 Sensitive: When you use this setting, the voice recognition system is not as strict while performing voice recognition tasks, in other words, under this setting the system will respond to your voice most of the time and you won't have many non-responsive situations. You should set the system to **Sensitive** when in continually noisy environments, for example when on a train or in a factory, etc.



Normal: **Normal** is the default setting and is best for the average environment.

Accurate: Under the **Accurate** setting, the system is more strict when performing voice pattern matching. Recognition errors are less likely to occur when you set the system to **Accurate**.

FAQ

Question: I want to make a call to my friend Andy Miller, but I'm tired of reading manuals. What do I need to know if I just want to make phone calls?

Answer: Make sure you have Andy Miller's name and phone number in the contact database. Press the **Voice Commander** Button, and say "Call Andy Miller." The system will guide you through it.

Question: I added a new contact but it is not recognized.

Answer:

1. The system only recognizes English words and characters or digits. Any symbols or marks will be ignored. However you can still make a voice tag for these items.
2. When the number of contacts exceeds 1,000 entries, the system will not recognize the excessive entries, until activated manually by the user.
3. To have a look at the status of the contact's voice command attributes, please go to the **Contacts** setting page in **Voice Commander Settings**.

Question: I recorded a voice tag for my friend last month, but I forgot what I recorded. Do I need to redo the recording?

Answer: No! Just tap **Voice Commander Settings**, the **Contacts** tab, select the contact, and then tap  **Play** Button.

Question: I performed digit training today, but I found that the accuracy is worse than before, what do I do now?

Answer: You can retry the digit training again in a “quiet” place. And if it still doesn’t help, disable the adapted model and use the default one. To disable the adapted model, tap **Voice Commander Settings**, the **Digit Trainer** tab, and then uncheck “Use adapted model.” Or just tap  **Remove All** Button to remove the model. It will save you some memory this way.

Question: I accidentally activated **Voice Commander**, how can I abort it?

Answer: Say “Goodbye.”

14 Specifications /

Item	Description
Operating system	Windows Mobile® 6 Professional
Processor	Samsung SC3 2442, 400 MHz
Memory	128 MB Flash ROM, 64 MB SDRAM
Display	2.8", 640 x 480 (VGA), 65,536 colors, TFT-LCD
Communication	<ul style="list-style-type: none">■ GSM/EDGE Quad-band 850/900/1800/1900 MHz■ GPRS/EGPRS Class B, Multi-slot Class 10■ Bluetooth® v2.0 Class 2 + EDR■ WiFi IEEE 802.11b/g
GPS	Built-in GPS module (SiRF Star III) TMC function supported * (* subject to change by region)
Expansion slot	MicroSD
Camera	Built-in 2.0 Mega Pixels Up to 1600 x 1200 Resolution Support Auto-Macro Focus
Interface/Audio	Built-in microphone and speaker External stereo headset jack
Interface/Data	USB Sync, headset jack
Power supply	Battery: 1530 mAh Li-Ion Polymer, rechargeable, replaceable AC Adapter: 100~240 VAC/50~60 Hz, 5V/1A DC

Item	Description
Environmental temperature	Daily operation: 0°C ~ 40°C; storage: -10°C ~ 50°C
Environmental humidity	45% ~ 85%
Dimensions	113 x 59.5 x 15.5 mm (LxWxH) 146 g including battery
Optional accessories	Battery, Car charger, Bluetooth® Headset

▣ Design and specifications are subject to change without notice.

15 Regulation Notice and Safety Declaration

SAR Information

Read this manual carefully before using.

Warning: Reduced electromagnetic waves, please use properly.

GSM Head: 0.743 mW/g (10g)

DCS Head: 0.441 mW/g (10g)

CE WLAN Body: 0.127 mW/g (10g)

Health and Safety Information

Electrical and Battery Safety

- ♥ Use only the AC adapter provided with this product. Do not use similar items from other products. The provided AC adapter is for use with this product only. Do not use it for other electrical products.
- ♥ Follow the specifications of the battery manufacturer: Avoid charging the battery when the environmental temperature is higher than 45°C. Do not store or use the battery when the environmental temperature is higher than 50°C. Otherwise, battery expansion or leakage may occur.
- ♥ Do not attempt to disassemble, pound, pierce or damage the battery to avoid causing injury, danger or risk.

Application Environment Safety

- ♥ Do not directly expose the Pocket PC to any of the following environments: rapid changes of temperature, high temperature (such as direct exposure to sunlight or stoves), extremely low temperature, high pressure, areas with electrostatic discharge interference or dusty and humid places. Do not soak or wet the Pocket PC with water or any other liquid.
- ♥ Do not place the Pocket PC near electrical appliances (such as TVs, computers, scanners, disc players, faxes, hair dryers, etc.) that may generate electrostatic discharge interference.
- ♥ Never drop the Pocket PC nor subject it to strong impact.
- ♥ Do not use ordinary pen or any object with a sharp tip to tap the Pocket PC cover or screen (LCD panel) to avoid damaging and scratching the surfaces.
- ♥ Do not use corrosive or volatile liquids to wipe the Pocket PC. If necessary, use a soft cloth or tissue to wipe the Pocket PC.

Warranty Security

- ♥ In case the Pocket PC is damaged, kindly return it to your place of purchase. Do not attempt to disassemble this device on your own as this may void the warranty.
- ♥ If any hazards result from the failure of the user to comply with usage rules, we will not be held responsible for any resulting warranty claims.

Data Security

- ♥ This company is not responsible for any data loss or damage to the Pocket PC due to improper use. Record important data in your notebook separately or use the USB accessories that come with this product to save important data to your computer or storage card.

Privacy Restrictions

- ♥ Some countries require full disclosure of recorded telephone conversations, and stipulate that you must inform the person with whom you are speaking that the conversation is being recorded. Always obey the relevant laws and regulations of your country when using the rewording feature of your Pocket PC Phone.

IMPORTANT SAFETY PRECAUTIONS

- ♥ When using this product, the safety precautions below must be taken to offset possible legal liabilities and damages.

Safety in airports, medical facilities, and inflammable environments

- ♥ When you are on a plane, in a medical facility or at a gas station where wireless communications devices are not allowed and must be turned off, please go to **Wireless Manager** and select the **ALL OFF** Button to turn off your Pocket PC's mobile phone, Bluetooth, and wireless LAN functions. By pressing the "Power Button" of the Pocket PC, you only turn off the display.

Safety In Aircrafts

- ♥ Due to the possible interference caused by this product to an aircraft's navigation system and its communications network, using this product on board an airplane is against the law in most country.

Interference With Medical Equipment Functions

- ♥ This product may cause medical equipment to malfunction. The use of this device is forbidden in most hospitals and medical clinics.

Environment Restrictions

- ♥ Do not use this product in gas or refueling stations. The use of this product is also prohibited in fuel storehouse, chemical plants, and locations containing explosives.

Safety For Environments

- ♥ Do not use this product in gas station, fuel depots, chemical plants or where blasting operations are in progress, or in potentially explosive atmospheres such as fueling areas, below deck on boats, fuel or chemical transfer or storage facilities, and areas where the air contains chemicals or particles, such as grain, dust, or Mattel powders. Please be aware that Sparks in such areas could cause an explosion or fire resulting in badly injury or even death.

Explosive Atmospheres

- ♥ When in any area with a potentially explosive atmosphere or where flammable materials exist, the product should be turned off and user should obey all signs and instructions. Sparks in such areas could cause an explosion or resulting in bally injury or even death. Users are advised not to use the equipment at refueling points such as service or gas stations. Users are reminded of the need to observe restrictions on the use of radio equipment in fuel depots, chemical plants or where blasting operations are in progress. Areas with a potentially explosive atmosphere are often, but not always, clearly marked. These include fueling areas, below deck on boats, fuel or chemical transfer or storage facilities, and areas where the air contains chemicals or particles, such as grain, dust, or metal powders.

Nonionizing Radiation

- ♥ This product should be operated in the suggested normal condition only to ensure the radioactive performance and safety of the interference. As with other mobile radio transmitting equipments, user are advised that for satisfactory operation of the equipment and for the safety of personnel, it is recommended that no part of the human body be allowed to come too close to the antenna during operation of the equipment.

Road Safety

- ♥ Vehicle drivers in motion are not permitted to use telephone service with handheld devices, except in case of emergency. In some countries, using hand-free devices as an alterative is allowed.



1. What features does the Pocket PC have?

Answer:

- ❶ Built-in 802.11b/g wireless networking module.
- ❷ The built-in camera module's sensitization, filming quality are better than other brands of Pocket PC in the same class.
- ❸ The latest Windows Mobile® 6 Professional operating system, with all its settings stored on a Flash ROM. You won't have to worry about losing your data even if the Pocket PC runs completely out of power. The extra-large Flash memory space is capable of storing a large amount of personal data and application programs.

2. How do I configure the wireless network? And how do I connect to the Internet?

Answer: **Wireless Manager** will assist you in managing your Bluetooth devices, GSM mobile devices, and your wireless networks.

- ❶ When you purchase credit points for connection to the Internet via a wireless connection, you will be given an IP address, DNS name server address, Proxy server, connection port number, and network key information, you will need this information to successfully connect to the Internet. Sometimes corporate networks may need additional information, please contact your company's network administrator for details. If you are using your wireless network for the first time, please refer to the "Configure your Wireless Network" section and set the necessary configurations.
- ❷ In general, you can activate the wireless connection by tapping the  icon in **Wireless Manager**. When your Pocket PC detects and connects to a available wireless network, a  icon will appear on the top of your screen, this means that your Pocket PC has successfully connected with a network hotspot (Access Point). At this time, the indicator on the upper left of your pocket PC will flash orange.

3. My Pocket PC cannot boot. What should I do about it?

Answer:

- ❶ Make sure the Pocket PC battery you use still has enough power.
- ❷ Plug your Pocket PC into the charger, and make sure the red charging indicator lights up. Press the “Power Button.”
- ❸ If you have done the above but your Pocket PC still cannot boot, proceed with the following step: Remove the Pocket PC back cover, and check the battery lock is in place. If not, the system cannot be started.

4. My Pocket PC has a screen freeze or the system does not respond.
What should I do about it?

Answer:

- ❶ You may reset your Pocket PC. It means to re-start the whole system to release unnecessary resources so that the system can return to normal.
- ❷ If you have reset your Pocket PC but it still cannot operate normally, then you need to carry out a cold boot to solve this problem.

How to carry out a cold boot: Press and hold the “Power Button” with one hand, and use the stylus tip to press the “Reset Button” with the other hand. Release the “Power Button” and the “Reset Button” at the same time. **If you answer “Yes” to the question displayed after a cold boot. (Erase all data and load default?) The programs installed by yourself, self-made settings, and self-made data (e.g., “Contacts” and “Calendar”) will disappear. And return to their default settings.**

As a result, we suggest you copy your data to the storage card. Data stored in the storage card will not vanish because of a cold boot. Or you can synchronize the data on your Pocket PC with your desktop computer.

5. Why doesn't my Pocket PC make any sound?

Answer:

- ❶ Tap the speaker icon  on the top right of the screen, then select the volume control options, or adjust the volume of the incoming call sound.
- ❷ Alternatively, you may use the volume control key to control the volume.

6. Why does my Pocket PC screen automatically become dark?

Answer: Tap , **Settings**, the **System** tab, **Backlight**, and then the **Battery power** or the **External power** tab. You may find that if you use battery power, the backlight automatically shuts down after 30 seconds by default; the external power shuts down after 1 minute by default. If you think these times are too short, you may extend them as needed.

7. When I want to open a program or file, a warning message "Not enough memory" pops up. What should I do about it?

Answer: Because your Pocket PC's memory is shared by storage memory and program memory, the following methods are available. You may choose the one that works best for you.

- ❶ Remove the programs you installed or that are not frequently used to release program memory space.
- ❷ Delete data that is not used frequently or unnecessary to release storage memory space.

8. The characters on the screen are too small to read. How can I enlarge them?

Answer: Tap , **Settings**, the **System** tab, **Screen**, and then the **Text size** tab. You may adjust the text size as you wish. Also, you may select the landscape orientation in the **General** tab screen. Try and change them so that you can read more smoothly.

9. The contact point of my stylus is not quite precise. What should I do about it?

Answer: Align the screen in place, and the touch screen can respond to the operation of your stylus more precisely. The following two ways will bring you into the touch screen calibration mode.

❶ Tap , **Settings**, the **System** tab, **Screen**, and then **Align Screen** Button.

❷ Simultaneously press the **Left Soft-Key** on the bottom-left of the Pocket PC and the round execution button in the center of the navigation pad.

10. The hardware buttons of my Pocket PC doesn't make any response or calls a wrong program. What should I do about it?

Answer: Tap , **Settings**, the **Personal** tab, and then **Buttons**. Check each button for correct setup.

11. My Pocket PC's Activesync cannot be executed or make a connection. What should I do about it?

Answer:

- ① Make sure you have installed Activesync version 4.5 or above. The companion CD contains the software. If you have lost the CD, you may download it from the Microsoft Website.
- ② Make sure the charger as well as the USB cable provided along with the product are already connected up to your PC end.
- ③ Make sure you are not executing another program that uses the same serial port you selected for operation during installation.
- ④ If your Activesync is still not working, remove and delete the old version of Activesync software at the PC end and install it once again.

12. My PC uses Windows Vista™ operating system, how will it handle the Pocket PC connection?

Answer:

- ① Please make sure that the Windows Mobile® Device Center included in the companion CD is installed.
- ② Make sure that the included USB cable is properly connected to the PC port.

13. My PC currently has Microsoft Outlook installed, will it work with the Pocket PC?

Answer: Refer to the download link which you can see in the companion CD. If your current Microsoft Outlook version is older than that, uninstall the older version, then install the Microsoft Outlook limited trial version. When the trial period is over, contact with Microsoft for more information on purchasing the retail version.

First Version: May 2007
Current Version: May 2007, Version 1
Number: 20070430